

Hardware Debugger Guide

Introduction

Getting Started

Design Preparation

Connecting Your Cable

***Programming a Device or a
Daisy Chain***

Debugging a Device

Customizing the Interface

Menu Commands

Glossary of Terms

Console Commands



The Xilinx logo shown above is a registered trademark of Xilinx, Inc.

FPGA Architect, FPGA Foundry, NeoCAD, NeoCAD EPIC, NeoCAD PRISM, NeoROUTE, Timing Wizard, TRACE, XACT, XILINX, XC2064, XC3090, XC4005, XC5210, and XC-DS501 are registered trademarks of Xilinx, Inc.



The shadow X shown above is a trademark of Xilinx, Inc.

All XC-prefix product designations, A.K.A. Speed, Alliance Series, AllianceCORE, BITA, CLC, Configurable Logic Cell, CORE Generator, CoreGenerator, CoreLINX, Dual Block, EZTag, FastCLK, FastCONNECT, FastFLASH, FastMap, Foundation, HardWire, LCA, LogiBLOX, Logic Cell, LogiCORE, LogicProfessor, MicroVia, MultiLINX, PLUSASM, PowerGuide, PowerMaze, QPro, RealPCI, RealPCI 64/66, SelectI/O, Select-RAM, Select-RAM+, Smartguide, Smart-IP, SmartSearch, SmartSpec, SMARTswitch, Spartan, TrueMap, UIM, VectorMaze, VersaBlock, VersaRing, Virtex, WebLINX, XABEL, XACT*step*, XACT*step* Advanced, XACT*step* Foundry, XACT-Floorplanner, XACT-Performance, XAM, XAPP, X-BLOX, X-BLOX plus, XChecker, XDM, XDS, XEPLD, Xilinx Foundation Series, XPP, XSI, and ZERO+ are trademarks of Xilinx, Inc. The Programmable Logic Company and The Programmable Gate Array Company are service marks of Xilinx, Inc.

All other trademarks are the property of their respective owners.

Xilinx, Inc. does not assume any liability arising out of the application or use of any product described or shown herein; nor does it convey any license under its patents, copyrights, or maskwork rights or any rights of others. Xilinx, Inc. reserves the right to make changes, at any time, in order to improve reliability, function or design and to supply the best product possible. Xilinx, Inc. will not assume responsibility for the use of any circuitry described herein other than circuitry entirely embodied in its products. Xilinx, Inc. devices and products are protected under one or more of the following U.S. Patents: 4,642,487; 4,695,740; 4,706,216; 4,713,557; 4,746,822; 4,750,155; 4,758,985; 4,820,937; 4,821,233; 4,835,418; 4,855,619; 4,855,669; 4,902,910; 4,940,909; 4,967,107; 5,012,135; 5,023,606; 5,028,821; 5,047,710; 5,068,603; 5,140,193; 5,148,390; 5,155,432; 5,166,858; 5,224,056; 5,243,238; 5,245,277; 5,267,187; 5,291,079; 5,295,090; 5,302,866; 5,319,252; 5,319,254; 5,321,704; 5,329,174; 5,329,181; 5,331,220; 5,331,226; 5,332,929; 5,337,255; 5,343,406; 5,349,248; 5,349,249; 5,349,250; 5,349,691; 5,357,153; 5,360,747; 5,361,229; 5,362,999; 5,365,125; 5,367,207; 5,386,154; 5,394,104; 5,399,924; 5,399,925; 5,410,189; 5,410,194; 5,414,377; 5,422,833; 5,426,378; 5,426,379; 5,430,687; 5,432,719; 5,448,181; 5,448,493; 5,450,021; 5,450,022; 5,453,706; 5,455,525; 5,466,117; 5,469,003; 5,475,253; 5,477,414; 5,481,206; 5,483,478; 5,486,707; 5,486,776; 5,488,316; 5,489,858; 5,489,866; 5,491,353; 5,495,196; 5,498,979; 5,498,989; 5,499,192; 5,500,608; 5,500,609; 5,502,000; 5,502,440; 5,504,439; 5,506,518; 5,506,523; 5,506,878; 5,513,124; 5,517,135; 5,521,835; 5,521,837; 5,523,963; 5,523,971; 5,524,097; 5,526,322; 5,528,169; 5,528,176; 5,530,378; 5,530,384; 5,546,018; 5,550,839; 5,550,843; 5,552,722; 5,553,001; 5,559,751; 5,561,367; 5,561,629; 5,561,631; 5,563,527; 5,563,528; 5,563,529; 5,563,827; 5,565,792; 5,566,123; 5,570,051; 5,574,634; 5,574,655; 5,578,946; 5,581,198; 5,581,199; 5,581,738; 5,583,450; 5,583,452; 5,592,105; 5,594,367; 5,598,424; 5,600,263; 5,600,924; 5,600,271; 5,600,597; 5,608,342; 5,610,536; 5,610,790; 5,610,829; 5,612,633; 5,617,021; 5,617,041; 5,617,327; 5,617,573; 5,623,387; 5,627,480; 5,629,637; 5,629,886; 5,631,577; 5,631,583; 5,635,851; 5,636,368; 5,640,106; 5,642,058; 5,646,545; 5,646,547; 5,646,564; 5,646,903; 5,648,732; 5,648,913; 5,650,672; 5,650,946; 5,652,904; 5,654,631; 5,656,950; 5,657,290; 5,659,484; 5,661,660; 5,661,685; 5,670,896; 5,670,897; 5,672,966; 5,673,198; 5,675,262; 5,675,270; 5,675,589; 5,677,638; 5,682,107; 5,689,133; 5,689,516; 5,691,907; 5,691,912; 5,694,047; 5,694,056; 5,724,276; 5,694,399; 5,696,454; 5,701,091; 5,701,441; 5,703,759; 5,705,932; 5,705,938; 5,708,597; 5,712,579; 5,715,197; 5,717,340; 5,719,506; 5,719,507; 5,724,276; 5,726,484; 5,726,584; 5,734,866; 5,734,868; 5,737,234; 5,737,235; 5,737,631; 5,742,178; 5,742,531; 5,744,974; 5,744,979; 5,744,995; 5,748,942; 5,748,979; 5,752,006; 5,752,035; 5,754,459; 5,758,192; 5,760,603; 5,760,604; 5,760,607; 5,761,483; 5,764,076; 5,764,534; 5,764,564; 5,768,179; 5,770,951; 5,773,993; 5,778,439; 5,781,756; 5,784,313; 5,784,577; 5,786,240; 5,787,007; 5,789,938; 5,790,479;

5,790,882; 5,795,068; 5,796,269; 5,798,656; 5,801,546; 5,801,547; 5,801,548; 5,811,985; 5,815,004; 5,815,016; 5,815,404; 5,815,405; 5,818,255; 5,818,730; 5,821,772; 5,821,774; 5,825,202; 5,825,662; 5,825,787; 5,828,230; 5,828,231; 5,828,236; 5,828,608; 5,831,448; 5,831,460; 5,831,845; 5,831,907; 5,835,402; 5,838,167; 5,838,901; 5,838,954; 5,841,296; 5,841,867; 5,844,422; 5,844,424; 5,844,829; 5,844,844; 5,847,577; 5,847,579; 5,847,580; 5,847,993; 5,852,323; Re. 34,363, Re. 34,444, and Re. 34,808. Other U.S. and foreign patents pending. Xilinx, Inc. does not represent that devices shown or products described herein are free from patent infringement or from any other third party right. Xilinx, Inc. assumes no obligation to correct any errors contained herein or to advise any user of this text of any correction if such be made. Xilinx, Inc. will not assume any liability for the accuracy or correctness of any engineering or software support or assistance provided to a user.

Xilinx products are not intended for use in life support appliances, devices, or systems. Use of a Xilinx product in such applications without the written consent of the appropriate Xilinx officer is prohibited.

Copyright 1991-1999 Xilinx, Inc. All Rights Reserved.

About This Manual

This manual describes Xilinx's Hardware Debugger program, a tool used for configuring and debugging FPGA devices.

Before using this manual, you should be familiar with the operations that are common to all Xilinx software tools: how to bring up the system, select a tool for use, specify operations, and manage design data. These topics are covered in the *Quick Start Guide*.

Other publications you can consult for related information are *The Programmable Logic Data Book*, *Development System Reference Guide*, and *Hardware User Guide*.

Additional Resources

For additional information, go to <http://support.xilinx.com>. The following table lists some of the resources you can access from this page. You can also directly access some of these resources using the provided URLs.

Resource	Description/URL
Tutorial	Tutorials covering Xilinx design flows, from design entry to verification and debugging http://support.xilinx.com/support/techsup/tutorials/index.htm
Answers Database	Current listing of solution records for the Xilinx software tools Search this database using the search function at http://support.xilinx.com/support/searchtd.htm
Application Notes	Descriptions of device-specific design techniques and approaches http://support.xilinx.com/apps/appsweb.htm

Resource	Description/URL
Data Book	Pages from <i>The Programmable Logic Data Book</i> , which describe device-specific information on Xilinx device characteristics, including read-back, boundary scan, configuration, length count, and debugging http://support.xilinx.com/partinfo/databook.htm
Xcell Journals	Quarterly journals for Xilinx programmable logic users http://support.xilinx.com/xcell/xcell.htm
Tech Tips	Latest news, design tips, and patch information on the Xilinx design environment http://support.xilinx.com/support/techsup/journals/index.htm

Manual Contents

This manual covers the following topics.

- Chapter 1, “Introduction,” defines the Hardware Debugger and its operation.
- Chapter 2, “Getting Started,” briefly describes the interface and summarizes the design and hardware requirements for running the Hardware Debugger.
- Chapter 3, “Design Preparation,” is a step-by-step explanation of how to prepare your design and create a configuration data file for use with the Hardware Debugger.
- Chapter 4, “Connecting Your Cable,” describes the different cables available for use with the Hardware Debugger and how to connect them to your computer and target device. It also describes the different software settings used to implement the programming and debugging functions and explains how to test the MultiLINX™ Cable and the XChecker™ Cable hardware.
- Chapter 5, “Programming a Device or a Daisy Chain,” explains how to download a design to a single device and verify that the design was sent in its entirety. It also explains how to configure multiple devices.
- Chapter 6, “Debugging a Device,” explains how to display the states of specific signals in a device that was programmed with a design.

-
- Chapter 7, “Customizing the Interface,” explains how to use macros, how to control the waveform display parameters, and how to use the additional features to optimize your use of the Hardware Debugger.
 - Chapter 8, “Menu Commands,” covers all the commands and dialog boxes available from the Hardware Debugger.
 - Appendix A, “Glossary of Terms,” defines common terms used in the context of the Hardware Debugger.
 - Appendix B, “Console Commands,” interprets the syntax of the commands that are displayed in the Console window each time you execute a menu command. You can execute a command directly by typing the appropriate syntax in the Console window command bar. Console commands also constitute the building blocks of macros.

Conventions

This manual uses the following typographical and online document conventions. An example illustrates each typographical convention.

Typographical

The following conventions are used for all documents.

- `Courier font` indicates messages, prompts, and program files that the system displays.

```
speed grade: -100
```

- **Courier bold** indicates literal commands that you enter in a syntactical statement. However, braces “{}” in Courier bold are not literal and square brackets “[]” in Courier bold are literal only in the case of bus specifications, such as bus [7:0].

```
rpt_del_net=
```

Courier bold also indicates commands that you select from a menu.

```
File → Open
```

- *Italic font* denotes the following items.
 - Variables in a syntax statement for which you must supply values

```
edif2ngd design_name
```

- References to other manuals

See the *Development System Reference Guide* for more information.

- Emphasis in text

If a wire is drawn so that it overlaps the pin of a symbol, the two nets are *not* connected.

- Square brackets “[]” indicate an optional entry or parameter. However, in bus specifications, such as bus [7:0], they are required.

```
edif2ngd [option_name] design_name
```

- Braces “{ }” enclose a list of items from which you must choose one or more.

```
lowpwr = {on | off}
```

- A vertical bar “|” separates items in a list of choices.

```
lowpwr = {on | off}
```

- A vertical ellipsis indicates repetitive material that has been omitted.

```
IOB #1: Name = QOUT'  
IOB #2: Name = CLKIN'  
.  
.  
.
```

- A horizontal ellipsis “. . .” indicates that an item can be repeated one or more times.

```
allow block block_name loc1 loc2 . . . locn;
```

Online Document

The following conventions are used for online documents.

- Red-underlined text indicates an interbook link, which is a cross-reference to another book. Click the red-underlined text to open the specified cross-reference.
- Blue-underlined text indicates an intrabook link, which is a cross-reference within a book. Click the blue-underlined text to open the specified cross-reference.

Introduction

This chapter provides an overview of the Hardware Debugger, and includes the following sections.

- “Overview”
- “Architectures”
- “Hardware Debugger Features”
- “Design and Hardware Considerations”

Overview

The Hardware Debugger is a graphical interface that allows you to download a design to a device, verify the downloaded configuration, and display the internal states of the programmed device. Use the program to perform the following tasks.

- Download a BIT file to an FPGA, or a PROM file to a daisy chain of FPGAs.
- Verify the configuration data of a single device using the Multi-LINX™ Cable or the XChecker Cable.
- Debug the internal logic states of a configured device using an XChecker Cable.

The graphical based Hardware Debugger replaces the command line based XChecker program.

Refer to the “Programming a Device or a Daisy Chain” chapter for information on how to open, download, and verify your design. Refer to the “Debugging a Device” chapter for information on how to read back and debug your configured device.

Note: Before invoking the Hardware Debugger, connect the configuration cable to your computer and target board; you should also be aware of the design and hardware issues described in the “Design and Hardware Considerations” section in this chapter.

Architectures

You can use the Hardware Debugger with the following Xilinx devices:

- XC3000A/L™
- XC3100A/L™
- XC4000E/L™
- XC4000EX™/XL™/XV™/XLA™
- XC5200™
- Spartan™/XL™
- Spartan2™
- Virtex™
- VirtexE™
- XC9500™/XL™/XV™

The Spartan, Virtex, XC3000, XC4000, and XC5200 families compose the FPGA families. The XC9500 families compose the CPLD families.

Hardware Debugger Features

You can use the Hardware Debugger to perform the following functions.

- Configure one or more devices
- Verify configuration data for single devices
- Debug a single device in synchronous or asynchronous mode
- Generate multiple graphical and textual waveforms for probe points
- Group signals for waveforms for later use
- Reuse debug settings from one session to another

- Create macros (command scripts) by copying commands from the Console window into a macro window and saving them as macro files
- Examine real-time digital values of the XChecker pins
- Use the XChecker Cable to probe and display the values of internal nodes of an FPGA device as listed in the table.

Table 1-1 Probe Points in FPGA Devices

XC3000	XC4000	XC5200
CLB outputs	CLB outputs	—
IOB outputs	IOB outputs	—
—	RAM/ROM bits	internal ROM bits
Flip-flop outputs	Flip-flop outputs	Flip-flop outputs

Design and Hardware Considerations

Before using the Hardware Debugger, review the requirements for the design entry phase in the following table. These requirements are described in detail in the “Design Preparation” chapter and the “Connecting Your Cable” chapter.

Table 1-2 Requirements for Hardware Debugger Operations

	Downloading	Verification	Debugging
File Types	BIT, RBT, PROM	BIT, LL	
Design Symbols for Virtex/ Spartan2 devices	No symbols required	MSK, BIT, LL	
Design Symbols for XC4000/ XC5200 devices	No symbols required	READBACK STARTUP ^a	

Table 1-2 Requirements for Hardware Debugger Operations

	Downloading	Verification	Debugging
Configuration options for XC3000 devices	Enable pull-up resistor on DONE/PROG pin	- Enable pull-up resistor on DONE/PROG pin - Set Readback Mode to Once or On Command or use the -l option in BitGen	
Configuration options for XC4000/XC5200 devices	Enable pull-up on DONE pin	- Set readback clock to CCLk - Enable the Enable Bitstream Verification and In-Circuit Hardware Debugging option or use the -l option in BitGen	
Cable Type	MultiLINX, XChecker, serial, or parallel cables	MultiLINX™, XChecker Cable	
Pins Used	VCC GND CCLK D/P (DONE) DIN PROG (XC4000/XC5200) INIT RST	VCC GND CCLK RT RD	VCC GND CCLK RT RD TRIG ^a CLKI ^b CLKO ^b
Configuration Mode	Slave (SelectMAP mode is supported in the Hardware Debugger with the MultiLINX Cable.)	N/A	N/A

a. Optional. Use the STARTUP symbol to connect the design's global reset to the GSR (XC4000) or GR (XC5200) pin on the XChecker Reset. An inverter must be inserted in front of the GSR or GR pin to interface the active-Low XChecker reset with the active-High GSR/ GR reset.

b. Optional

Design Entry and Bitstream Generation

You need access to certain signals when you download and debug your designs.

For downloading, use any of the three configuration data file types (BIT, RBT, or PROM) and any download cable. You do not need any special symbols or configuration options to generate the configuration data.

Note: To create a PROM file using multiple bitstreams, use the PROM File Formatter. For more information, see the *PROM File Formatter Guide*.

For single device verification or debugging, use a BIT file, enable readback to generate an LL file in your design directory, and for XC4000/XC5200 devices. For Virtex, Spartan2, generate a MSK file for verification. Include the READBACK symbol in your design and optionally, the STARTUP symbol. In addition, you must use an XChecker Cable.

Hardware Considerations

This section describes some hardware issues you should be aware of before using the Hardware Debugger.

Configuration Mode

When using the MultiLINX Cable the default mode is already set to slave serial. For Virtex and Spartan II the configuration mode dialog box will automatically pop up and ask the user for the proper configuration mode. This configuration mode dialog is only enabled for the MultiLINX Cable.

When using other download cables to configure a device or daisy chain of devices, you must set the device configuration mode to slave serial. You must set M0, M1, and M2 to VCC, and if you intend to use them as user I/Os, use 4.7 kilohm pull-ups. Refer to the *Development System Guide* or *The Programmable Logic Data Book* for information on setting the mode pins.

Target Board Selection

Your target board can be either a Xilinx FPGA demonstration board or your own board. You can use the demonstration boards to test most designs.

If you are using an FPGA demonstration board, set up the board as explained in the *Hardware Debugger Watch Tutorial*. The *Watch Tuto-*

rials including the *Hardware Debugger* are located on the support.xilinx.com web page.

Use the following URL: <http://support.xilinx.com/support/techsup/tutorials/index.htm>.

You must set the board switches and connect the appropriate cable. If you are using your own board, you must configure the board and connect the appropriate cable. Refer to the “Connecting Your Cable” chapter for information.

Single or Multiple Device Configuration

You can configure one device or a daisy chain. See the “XChecker Operation Mode Connections” table in the “Connecting Your Cable” chapter for information on pin connections.

The MultiLINX Cable must be configured only for download and verify. Refer to the “MultiLINX™ Cable” chapter of the *Hardware User Guide* for information on the MultiLINX pin connections.

To configure a single device, connect the pins as specified for that particular device type. For a daisy chain of devices, connect the pins of the lead device for downloading. Connect the pins of the slave devices to the lead device as described in the *The Programmable Logic Data Book*.

Cable Connections

You can perform three main operations using the Hardware Debugger. Each operation requires a specific setup and, in the case of verification and debugging, a particular download cable. Refer to the “XChecker Operation Mode Connections” table in the “Connecting Your Cable” chapter for cable connections information for each operation.

Downloading

Connect the cable header to the pin assembly on your target board that is connected to the FPGA configuration pins. If you have an XChecker Cable, connect a cable header connector to the outermost slot of the XChecker Cable assembly.

Verification

For this operation, you must use an XChecker Cable. Connect both header connectors to the pin assembly on your target board.

Debugging

For this operation, you must use an XChecker Cable. Connect both header connectors to the pin assembly on your target board. If you are debugging in synchronous mode, you must connect the CLKI and CLKO pins; you can disconnect them for asynchronous mode debugging.

Note: The RST pin is only required for XC3000 downloading and debugging. You do not need to connect it for XC4000 or XC5200 downloading. Optionally, you can use it as a system design reset for XC4000 or XC5200 debugging.

Hardware Debugger Cable Support

The Hardware Debugger supports the following cables.

Table 1-3 Cable Support

Cable Name	Download	Readback & Verify	Debug
MultiLINX ^a	X	X	
XChecker ^b	X	X	X
Parallel	X		
Serial	X		

a. MultiLINX supports Slave Serial and SelectMAP modes.

b. XChecker supports only Slave Serial Mode. XChecker can support devices up to 256K bits.

Hardware Debugger Platform Support

The Hardware Debugger supports the following platforms.

Table 1-4 Platform Support

Cable	Platforms	Ports
MultiLINX	Sol/HP/WinNT/ Win95/Win98	RS-232,USB ^a
XChecker	Sol/HP/WinNT/ Win95/Win98	RS-232
Parallel	WinNT/Win95/Win98	Parallel

a. Only on Win 98/95C which has USB support.

Getting Started

This chapter explains how to start the Hardware Debugger. It describes the main screen and the three major tasks you can complete: download a design, verify configuration data, and debug the states of a configured device. In addition, it outlines the design and hardware requirements for using the Hardware Debugger. This chapter contains the following sections.

- “Starting the Hardware Debugger”
- “Exiting the Hardware Debugger”
- “Using the Interface”
- “Using Help”

Starting the Hardware Debugger

Note: Before using the Hardware Debugger, familiarize yourself with the design and hardware issues described in the “Design and Hardware Considerations” section of the “Introduction” chapter.

The Hardware Debugger runs on PCs and workstations. The following table summarizes the various ways of starting this tool.

Starting the Hardware Debugger	Workstation	PC
From the Design Manager	Yes	Yes
From the Command Line	Yes (UNIX)	Yes (DOS)
As a Standalone Tool	No	No

From the Design Manager

To start the Hardware Debugger from the Design Manager, follow these steps.

1. To run the Hardware Debugger on a specific design, select the desired revision in the Design Manager project view.
2. In the Design Manager toolbox, click the Hardware Debugger button, shown in the following figure.



Standalone Tool

If you installed the Hardware Debugger as a standalone tool on a PC, click the Hardware Debugger icon (shown in the previous figure) on the Windows desktop or select `hwdebugr.exe` from the Windows 95[®], Windows 98[®], or Windows NT[®] Start button.

From the Command Line

To start the Hardware Debugger from the UNIX[®] or DOS[™] command prompt, enter the following command.

```
hwdebugr
```

From the Foundation Project Manager

To launch the Hardware Debugger from the Foundation Project Manager, follow these steps.

1. Select the Device Programming icon in the Programming box on the Project Manager's Flow tab.

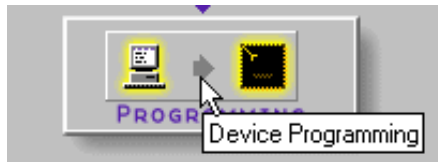

2. From the Select Program box, choose the Hardware Debugger.

For more information about accessing and using the Hardware Debugger from the Foundation Project Manager, see the “Verification and Programming” chapter of the *Foundation Series Guide*.

Exiting the Hardware Debugger

To exit the Hardware Debugger, select **File** → **Exit**. If you have an open waveform window, you are asked whether you want to save the data before quitting the application.

Using the Interface

This section describes the Hardware Debugger interface.

Main Window

The main window is shown in the following figure. By default, this window displays a title bar, menu bar, toolbar, and status bar. The Debug Control Panel dialog box appears when your design is generated for verification. To hide the toolbar, status bar, or control panel, select the appropriate commands from the View menu.

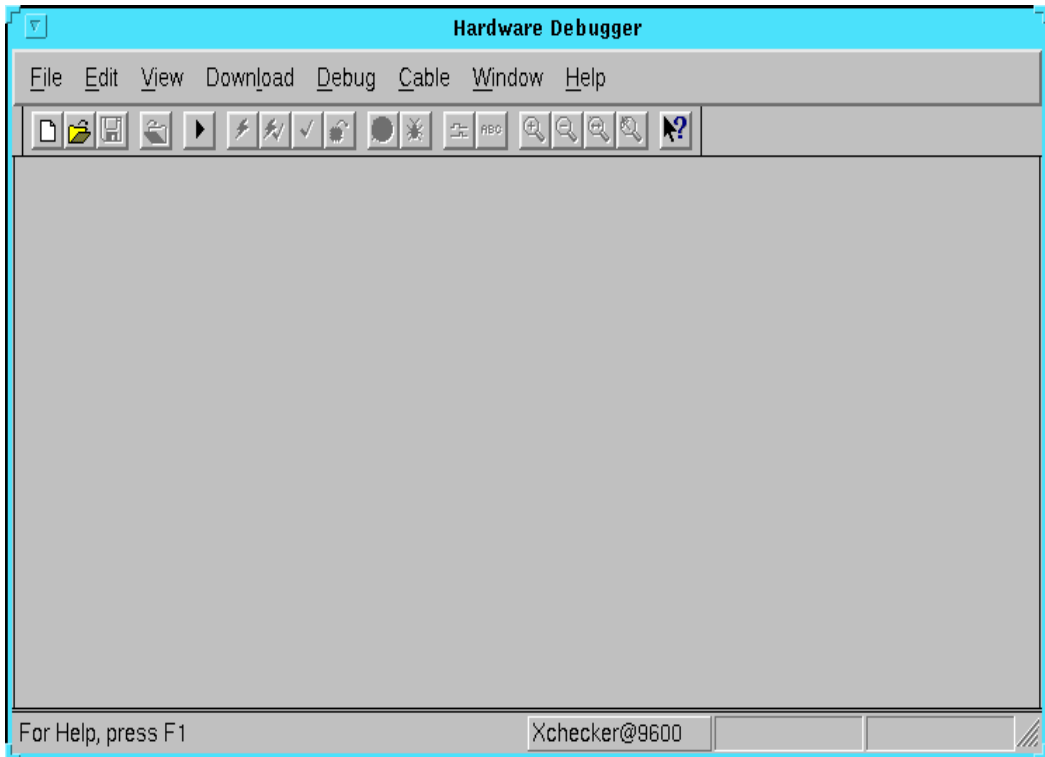

Figure 2-1 Hardware Debugger Window

Title Bar

The title bar displays the program name followed by the name of the currently loaded design.

Menu Bar

The menu bar, located at the top of the window, includes the File, Edit, View, Download, Debug, Cable, Window, and Help menus. You can also select menu commands by typing the letter underlined in the menu name while holding down the Alt key. Refer to the “Menu Commands” chapter for more information.

Toolbar

The toolbar, located below the menu bar, consists of buttons that you can use to execute commands. Place the mouse pointer over each button to display the command associated with the button. The command name appears as a “tool tip” and the status bar provides more descriptive information. For more information on each button, see the “Toolbar Buttons” section of the “Menu Commands” chapter.

Status Bar

The status bar, located at the bottom of the Hardware Debugger window, provides command and processing information. When you select a menu command, a brief description of the command’s function appears in the status bar. As the software processes, status messages are dynamically updated and displayed.

Control Panel

The Debug Control Panel is a dialog box that appears when your design is generated for verification or readback. Use the commands in the Control Panel to control aspects of the debugging session, such as readback snapshots, signal and signal groups displayed, design clocking, and design readback.

Commands and Dialog Boxes

You communicate with the Hardware Debugger by selecting commands from the menus, the toolbar, or the Debug Control Panel. Alternatively, you can run commands from the Console window. Most commands display dialog boxes in which you specify information and options.

Common Fields

The fields shown in the following table are common to most dialog boxes.

Table 2-1 Common Dialog Box Fields

Dialog Box Field	Function
OK	Closes the dialog box and implements the intended action according to the settings in the dialog box
Cancel	Closes the dialog box without effecting any action
Help	Displays information on that particular dialog box

File Open/File Save Dialog Boxes

The standard file open and file save dialog boxes allow you to load a project file, a saved waveform, or a saved macro. They also allow you to save a waveform or a macro. This type of dialog box includes a file browser.

Filter Dialog Boxes

Use Filter dialog boxes to specify criteria to select signals and groups for debugging, as described in the following steps.

1. Specify the pattern of the signal names to include in your display list by typing the characters in the field located in the Filter For Signals group. The characters can be alphanumeric or blank characters.
2. Include one or more wildcards (*) to perform a global search on the specified string.

Precede the character string with a wildcard to retrieve all signal names that end with the string of specified characters.

Append the wildcard to the character string to retrieve all signal names that start with the specified character string.

3. Click **Apply** after specifying the filter criteria.

The available signals list displays only the signals that match the selection criteria.

4. To clear the filter, click **C**lear or backspace over the information in the filter text box.

Selection Dialog Boxes

Use Selection dialog boxes to specify specific values and selections.

Selecting Commands and Dialog Box Options

To choose a menu item, a toolbar button, or a dialog box option, you can use the mouse or the keyboard.

Using the Mouse

1. Move the mouse cursor over the object to select, and click the left mouse button to select the object.

If you clicked on a toolbar button, a list box or a dialog box appears. If you clicked on a menu, menu options are displayed.
2. To exit a dialog box without making a selection, click **C**ancel or double-click the close box in the upper left corner of the dialog box.
3. To obtain help, click **H**elp in the dialog box.

Using the Keyboard

You can use the keyboard to select objects on your screen, such as a dialog box button or a menu option.

1. To select a dialog box option, use the **T**ab key to position the cursor on that object and highlight it. Press the **E**nter key to process the selection.

To exit a dialog box without making a selection, press the **E**sc key.
2. To choose a menu and display its commands, press the **A**lt key and the appropriate underlined letter key corresponding to the menu you want. For example, press **A**lt **F** to select the File menu.
3. Use the arrow keys to scroll down the list of commands in a menu or the options in a list box. Press **E**nter when the selection you want to use is highlighted or, in the case of a menu item, press the underlined letter corresponding to the menu command.

For example, press the **N** key to select the New command of the File menu.

Using Help

The Hardware Debugger includes a context-sensitive help and a Help menu. You can obtain help on commands and procedures through the Help menus or by selecting the Help toolbar button. In addition, the dialog boxes associated with many commands have a Help button that you can click to obtain context-sensitive help.

Help Menu

Use the following Help menu commands to get help.

- The Help Topics command opens the online help and lists the various topics available for the Hardware Debugger. From the Help Topics page, you can jump to command information or step-by-step instructions for using the Hardware Debugger. When you want to return to the help topic list, click the Help Topics button.
- The Online Documentation command provides access to the online documentation.
- The About Hardware Debugger command displays a popup window that shows the version number of the Hardware Debugger software and a copyright notice.

Toolbar Help Button

You can access context-sensitive help as follows.

1. Click the Help button in the toolbar.



The cursor changes to a question mark.

2. Click once with the left mouse button on the menu item or toolbar button for which you want help.

The Hardware Debugger displays help for the selected command or option.

Note: You can also press **Shift F1** to obtain context-sensitive help.

F1 Key

Pressing the F1 key on a dialog box displays help on that dialog box. Pressing the F1 key is the same as selecting Help → Help Topics, if no dialog boxes are displayed.

Help Button in Dialog Boxes

Many of the dialog boxes in the Hardware Debugger have a Help button that you can click to get help on the dialog box options. You can also press **Alt H** or **F1** on your keyboard with the cursor positioned over the dialog box to access the online help.

Design Preparation

This chapter describes how to prepare a design for use with the Hardware Debugger and how to generate the proper configuration files. The first section covers the special components needed to perform some of the Hardware Debugger operations. The second section discusses the various file types used by the Hardware Debugger and the options that must be specified to create these files correctly. This chapter includes the following sections.

- “Creating a Design”
- “Generating Configuration Data Files”

Creating a Design

To create a design for use with the Hardware Debugger, follow the design generation instructions for the type of operation you want to complete for your specific device.

This section provides instructions on starting the Hardware Debugger on the workstation or the PC.

Preparing a Design for Downloading

When using the Hardware Debugger to download a design only, you do not need any special symbols in the design. You can use the default values for all options.

Preparing a Design for Verification and Debugging

Readback is the process of reading a bitstream from an FPGA. The bitstream contains configuration information and information about

the state of the design. You can use the readback bitstream to verify the configuration and probe the internal states of your design.

XC3000

An XC3000 design does not need to be modified at the schematic or HDL level in order to perform readback. For XC3000 devices, a readback is initiated when a Low to High transition is applied to the M0/RTRIG pin. After the readback begins, the serial readback data is presented on the M1(RDATA) pin.

XC4000/XC5200

To provide more flexibility, the XC4000/XC5200 readback signals (RTRIG and RDATA) can be assigned to any of the user programmable device pins as well as the M0 and M1 pins. Because the readback signals are user programmable, you must use the READBACK component in the design when using the Hardware Debugger to verify or debug an XC4000 or an XC5200 device.

To prepare the design for verifying or debugging, use the following steps.

1. Include the READBACK symbol in the design schematic.
2. Connect IPAD, OPAD, IBUF, and OBUF primitives to the TRIG and DATA pins of the READBACK macro as shown in the “READBACK Symbol” figure. You can then lock the IPAD and OPAD components to any of the user-programmable I/O locations.

Note: If you want TRIG and DATA to correspond to the mode pins M0 and M1, replace the IPAD and OPAD primitives with the special primitives MD0 and MD1.

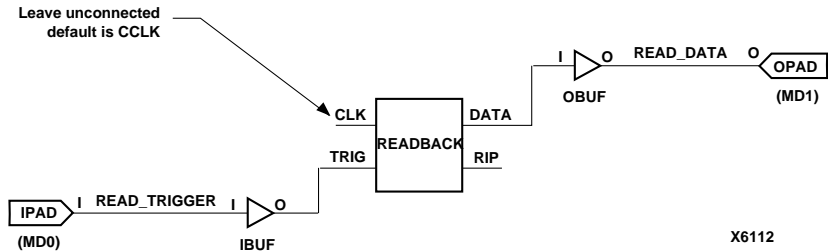

Figure 3-1 READBACK Symbol

3. If you plan to have the Hardware Debugger reset the flip-flops in the design, include the STARTUP symbol and connect the GSR (XC4000) or GR (XC5200) input pin to an unused input of the target device. You will later connect the input to the RESET pin on the XChecker cable.

Note: Because the XC4000/XC5200 reset is active-High and the Hardware Debugger assumes active-Low, the signal sent from the Hardware Debugger through the XChecker Cable or MultiLINX Cable must be inverted as shown in the following two figures.

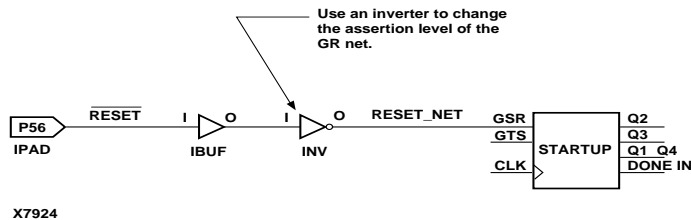

Figure 3-2 XC4000 STARTUP Symbol

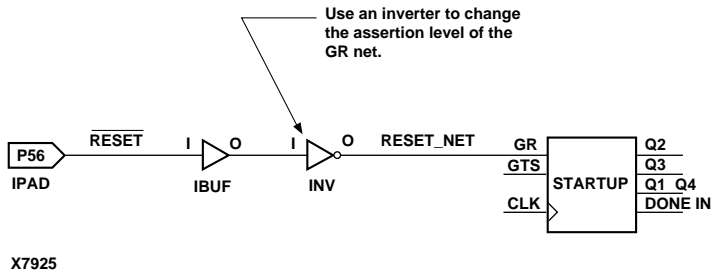

Figure 3-3 XC5200 STARTUP Symbol

The inverter preceding the STARTUP symbol implements the active-Low reset asserted by the Hardware Debugger.

Spartan

The Spartan device uses an internal configuration clock, CCLK, when configuring in a master mode. The configuration rate option allows you to select the rate for this clock. The default is Slow. Refer to the “Spartan Configuration Options” section of the *Design Manager/Flow Engine Guide* more information.

Generating Configuration Data Files

After the design is placed and routed, you must generate the configuration data files. The Hardware Debugger can download to a chain of multiple devices, known as a daisy chain, as well as to an individual device. The Hardware Debugger can only verify the configuration data and probe the internal states of a single device at a time. It is possible to verify and debug a device configured on a daisy chain only if you connect the XChecker cable directly to it. This process of probing a configured device is also known as read capture.

To generate a bitstream, open the implementation revision from the Design Manager. If you do not have a project for your design, use the Design Manager to create a project for that design. If you have a project for your design but the project has not been updated, run the **Design** → **New Version** command to read in the changes made in the schematic and to create a new version reflecting the updated schematic. Then, implement the design as explained in the “Imple-

menting a Design from the Design Manager” section of the *Design Manager/Flow Engine Guide*.

For detailed information on the various implementation and configuration options, see the “Implementation Flow Options” chapter of the *Design Manager/Flow Engine Guide*. Enable the Readback Enabled option in the Configuration Template (The Default is Enabled).

Creating Files for a Single XC3000 Device

To configure an XC3000 device, you need a bitstream. The Hardware Debugger accepts a bitstream as a BIT file, an RBT file, or a PROM file. To verify and/or debug a design, you must use a BIT file and have a logic allocation file (*design_name.ll*) in your design directory. Use the Design Manager to generate these files.

Creating Downloadable Files (XC3000)

Follow these steps to prepare your XC3000 designs for downloading.

1. From the Design Manager, click the left mouse button on the implementation revision, as shown in the following figure.
2. Select **Design** → **Implement**.

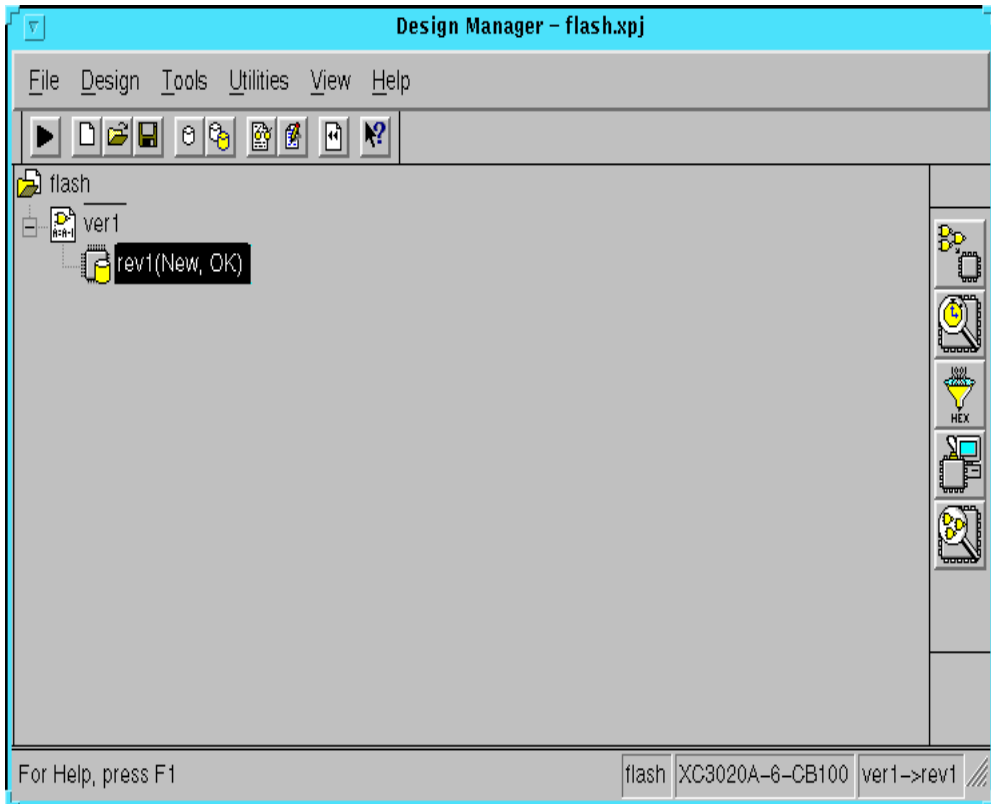

Figure 3-4 XC3000 Implementation Revision in the Design Manager

3. In the Implement dialog box, click the **Options** button.
The Options dialog box appears, as shown in the following figure.

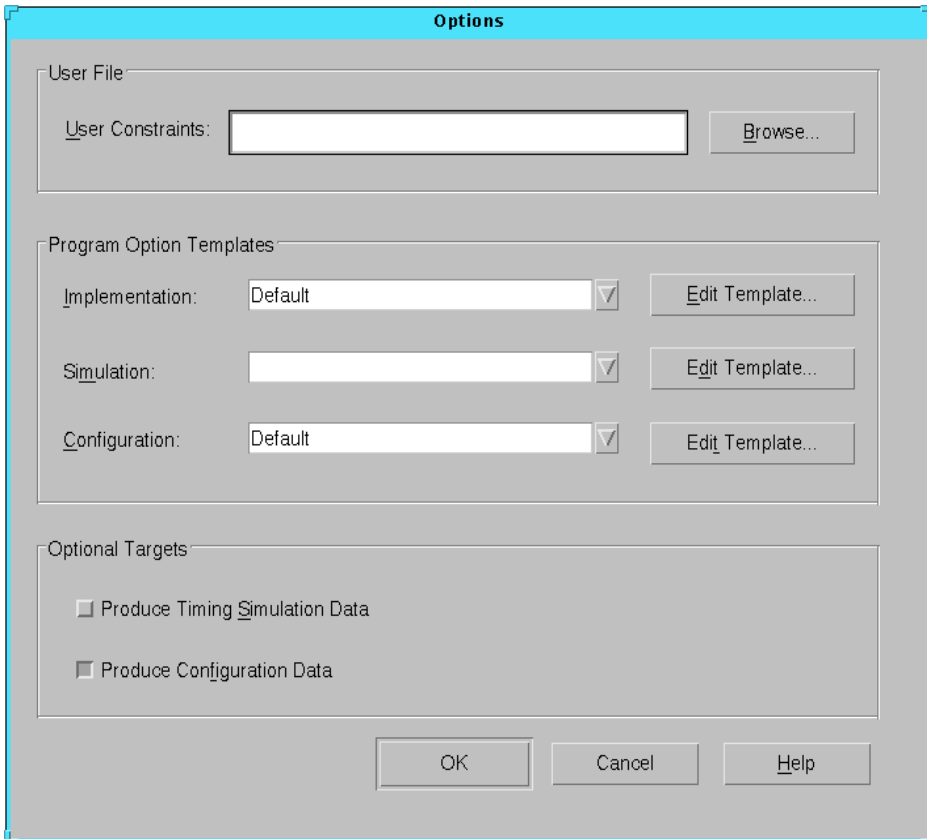

Figure 3-5 Design Manager Options Dialog Box

4. Select **Produce Configuration Data** in the Optional Targets group box.
5. Click the **Edit Template** button corresponding to the configuration template.

The Configuration Template dialog box appears, as shown in the following figure.

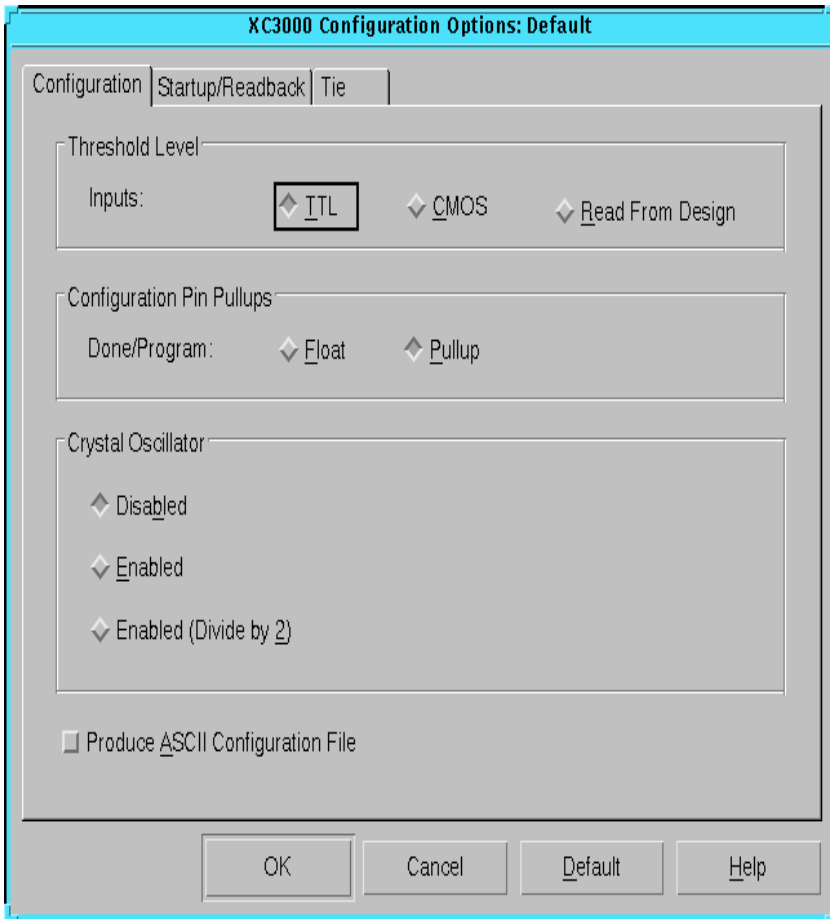

Figure 3-6 Design Manager Configuration Template Dialog Box

6. Select **Pu11up** next to the **Done/Program** pin in the Configuration Pin Pullups group box to enable a 2 to 8 kilohm pull-up resistor on the D/P pin.
7. Click **OK** to return to the Options dialog box or if you want to enable the readback options, continue with the “Creating Files for Verification and Debugging (XC3000)” section.
8. In the Options dialog box, click **OK** to return to the Implement dialog box.

9. In the Implement dialog box, select **Run** to implement the design and produce the configuration data.

Creating Files for Verification and Debugging (XC3000)

Follow these steps to implement XC3000 designs for verification and debugging.

1. Follow steps 1 through 6 in the preceding “Creating Downloadable Files (XC3000)” section to enable a pull-up resistor for the D/P pin for device configuration.
2. Select the Startup/Readback tab of the Configuration Template dialog box. The Startup/Readback tab appears, as shown in the following figure.

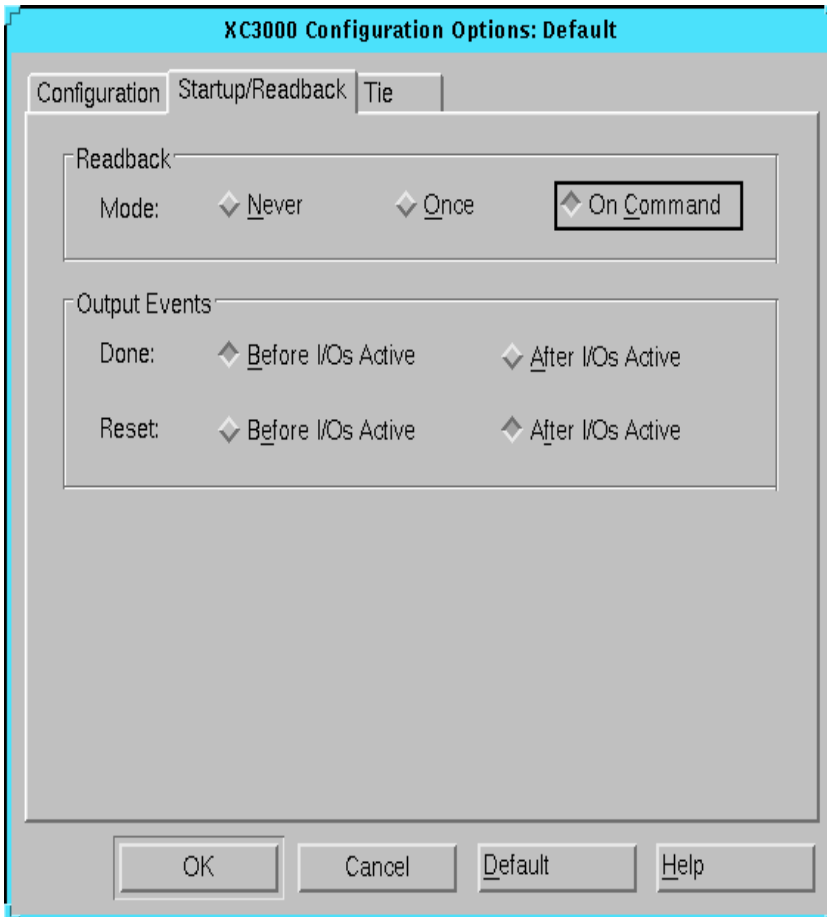

Figure 3-7 Configuration Template Startup/Readback Tab

3. Enable the readback capability by choosing **On Command** for the Readback option.

The software generates a logic allocation file (*design_name.ll*). The Hardware Debugger uses the *design_name.ll* file to identify bits in the readback bitstream that represent the values of design I/Os, latches, and flip-flops. For more information about configuration options, read the “Implementation Flow Options” chapter in the *Design Manager/Flow Engine Guide*.

4. Click **OK** in the Configuration Template dialog box to return to the Options dialog box.
5. In the Options dialog box, click **OK** to return to the Implement dialog box.
6. In the Implement dialog box, select **Run** to implement the design and produce the configuration data.

Creating Files for a Single XC4000 or XC5200 Device

To configure an XC4000 or XC5200 device, you need a bitstream, which can be either a BIT file, an RBT file, or a PROM file. To verify and/or debug a design, you must use a BIT file and have a logic allocation file (*design_name.ll*) in your design directory. Use the Design Manager to generate the necessary configuration files.

Creating Downloadable Files (XC4000/XC5200)

Follow these steps to prepare your XC4000 and XC5200 designs for downloading.

1. From the Design Manager, click the left mouse button on the implementation revision, as shown in the following figure.
2. Select **Design** → **Implement**.

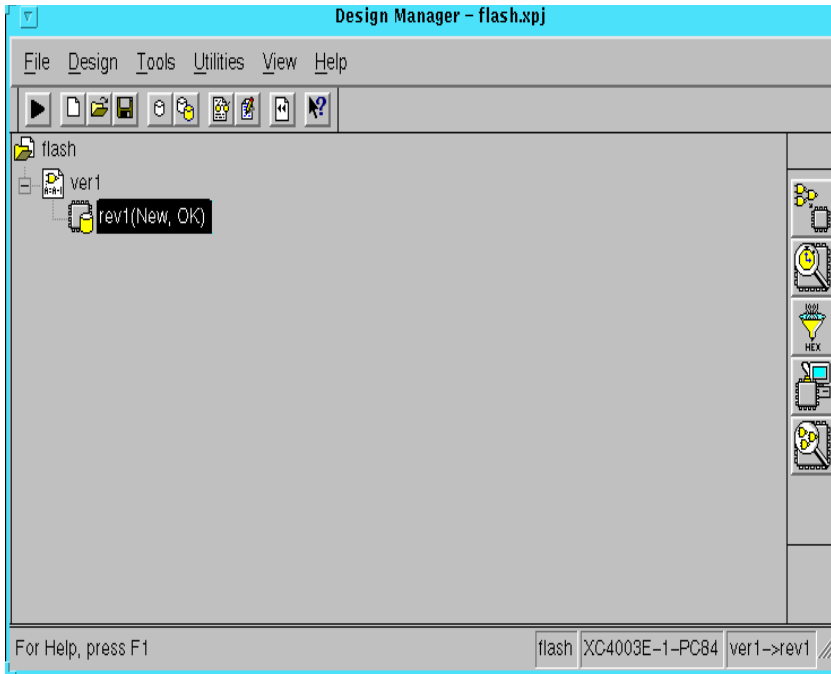

Figure 3-8 XC4000 Implementation Revision in the Design Manager

3. In the Implement dialog box, click **Options**.

The Options dialog box appears, as shown in the “Design Manager Options Dialog Box” figure.

4. Select **Produce Configuration Data** in the Optional Targets group box.
5. Click the **Edit Template** button corresponding to the configuration template.

The Configuration Template dialog box appears, as shown in the following figure.

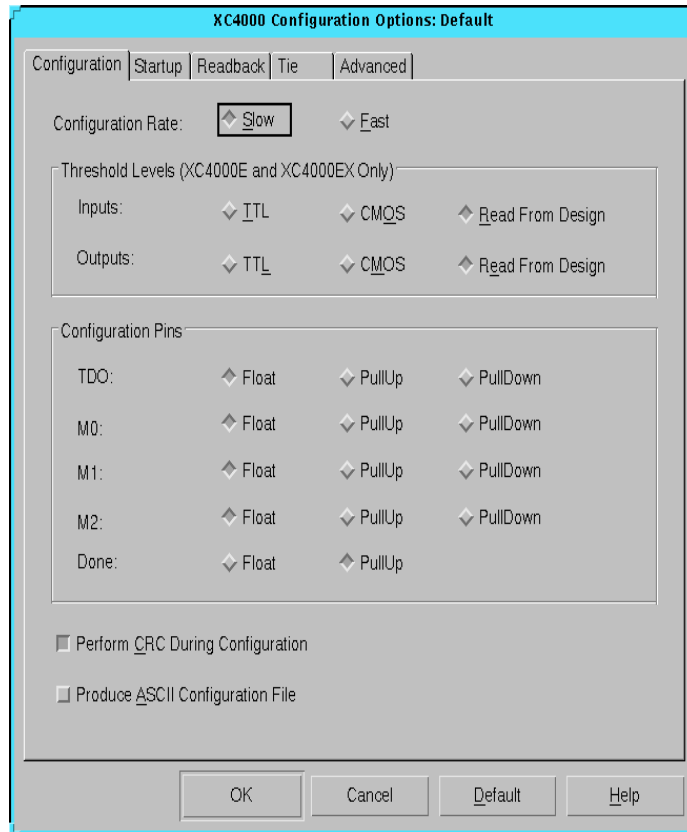

Figure 3-9 Design Manager Configuration Template Dialog Box

6. Select **Pu11Up** next to the DONE pin in the Configuration Pins group box to enable a pull-up resistor for the DONE pin.
7. This step is optional. Select **Perform CRC During Configuration** (default) to perform a cyclic redundancy check of your bitstream during configuration.

CRC bits are checksum bits that the FPGA uses to verify that the bitstream transmitted correctly.

8. This step is optional. Select **Produce ASCII Configuration File** to create a rawbits text (RBT) file, which is an ASCII representation of your configuration bitstream.

You can use the RBT file for download or to visually inspect your bitstream.

9. Click **OK** to return to the Options dialog box or if you want to enable the readback options, continue with the “Creating Files for Verification and Debugging (XC4000/XC5200)” section.
10. In the Options dialog box, click **OK** to return to the Implement dialog box.
11. In the Implement dialog box, select **Run** to compile your design and produce the configuration data.
12. To obtain help, click **Help** in the dialog box.

Creating Files for Verification and Debugging (XC4000/XC5200)

Follow these steps to implement XC4000 and XC5200 designs for verification and debugging.

1. Follow steps 1 through 6 in the preceding “Creating Downloadable Files (XC4000/XC5200)” section to enable a pull-up resistor for the D/P pin for device configuration.
2. In the Configuration Template dialog box, select the Readback tab. The Readback tab of the Configuration Template dialog box appears, as shown in the following figure.
3. Select **CCLK** as the readback clock.

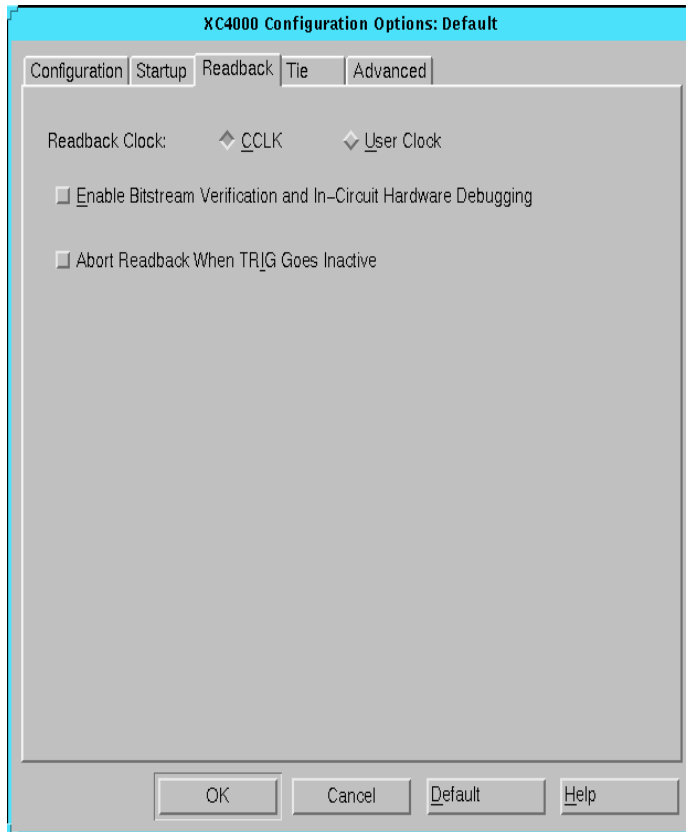

Figure 3-10 Configuration Template Readback Tab

4. Select **Enable Bitstream Verification and In-Circuit Hardware Debugging**.

This option generates the logic allocation file (*design_name.ll*). The Hardware Debugger uses the *design_name.ll* file to identify bits in the readback bitstream that represent the values of design I/Os, latches, and flip-flops. For more information about configuration options, read the “Implementation Flow Options” chapter in the *Design Manager/Flow Engine Reference/User Guide*.

Note: You cannot probe I/Os when working with an XC5200 device.

5. Click **OK** to return to the Options dialog box.

6. In the Options dialog box, click **OK** to return to the Implement dialog box.
7. In the Implement dialog box, select **Run** to compile the design and produce the configuration data.

Creating Files for Verification (Virtex)

Follow these steps to implement Virtex designs for verification.

1. Create .ll, .msk, and .bit files.
2. To enable Readback in the Design Manager use the Configuration Template (Enable Readback using Persist: X8). Refer to the “Working with Templates” section of the *Design Manager/Flow Engine Guide*.
3. Perform a Virtex Readback in SelectMAP.

Creating Files for Multiple Devices (Daisy Chains)

To configure a daisy chain of devices, you need a PROM file.

1. Produce the configuration data (BIT files) for each device, referring to the appropriate single device section.
2. Concatenate the device BIT files using the PROM File Formatter. For more information, refer to the *PROM File Formatter Guide*. Ensure that the PROM file contains the bitstreams in the same order as the devices on the target board.

Note: You can use a PROM file to download a daisy chain; however, you cannot use it to verify or debug a daisy chain.

Connecting Your Cable

This chapter describes the various download cables and the operations you can perform with each cable. It also explains how to connect your cable to your computer and target board, and how to set the target board's configuration mode.

Additionally, this chapter explains which connections are needed to download, verify, and debug. Information on diagnostics and troubleshooting for the MultiLINX™ Cable and the XChecker™ Cable is also included. This chapter contains the following sections.

- “Cable Support”
- “Cable Basics”
- “Cable Descriptions”
- “Cable Limitations”
- “Cable Baud Rates”
- “Connecting Cable to Host System”
- “Setting Up the Hardware”
- “Connecting Cable to Target System”
- “Setting the Cable Options”
- “Resetting the Cable”
- “MultiLINX Diagnostics”
- “XChecker Diagnostics”
- “Troubleshooting the MultiLINX Cable”
- “Troubleshooting the XChecker Cable”

Cable Support

The Hardware Debugger supports the following cables.

Table 4-1 Cable Support

Name	Function	Platform
MultiLINX Cable (Model: DLC6)	Download, Read-back & Verify	PC ^a
XChecker Cable (Model: DLC4)	Download, Read-back & Verify ^b	PC, Workstation
Parallel Cable III (Model: DLC5)	Download Only	PC
Serial Cable	Download Only	PC, Workstation

a. The MultiLINX Cable is only supported by the Hardware Debugger on PCs using Window 98/ NT with USB port support.

b. Limitations: You can us the XChecker with devices smaller then 256K bits. The XChecker is not recommended for use with larger devices.

Cable Basics

The Hardware Debugger communicates with your device via a cable. The cable can be a MultiLINX, XChecker, Parallel, or Serial cable. You can use any one of the four cables to download configuration data to a device or daisy chain of devices, but you can use the MultiLINX Cable to verify and the XChecker Cable to verify and debug.

The MultiLINX Cable supports all devices and has a fast USB communication port. The MultiLINX Cable supports Slave Serial and SelectMAP modes.

Perform the following steps when connecting your cable.

1. Determine the most suitable cable to use based on the tasks you want to perform.
2. Connect the cable to your host system.

3. Configure the target board to accept the needed cable connections.
4. Set your FPGA to slave serial mode configuration using the mode pins.
5. Connect the cable to your target system.
6. Power up the target board.
7. Start the Hardware Debugger.
8. Set the cable options from the Cable menu.

Cable Descriptions

This section describes the cables supported by the Hardware Debugger. There are four different types of cables: MultiLINX, XChecker, Parallel, and Serial.

For detailed cable information, refer to the “Cable Hardware” chapter of the *Hardware User Guide*.

MultiLINX

You can use the MultiLINX Cable to download and verify. The MultiLINX Cable hardware communicates with the host over the Universal Serial Bus (USB) at up to 12M bits/sec, or at variable baud rates over an RS-232 interface at up to 57600 bits/sec.

For detailed MultiLINX Cable information, refer to the “MultiLINX™ Cable” chapter of the *Hardware User Guide*. You can access the following mentioned application notes with descriptions of device-specific design techniques and approaches from the support page at <http://support.xilinx.com/support/searchtd.htm>.

- “Getting Started with MultiLINX Guide” application note is a quick reference to everything you need to know to use the MultiLINX Cable; using a USB device, Mixed Voltage environments, connections for all the supported Modes.
- “Integrating MultiLINX Cable with Target System Design” application note describes how to setup a Prototype application for use with the MultiLINX Cable.

- “Xilinx Cable Overview and Roadmap” application note describes all the cables, their capabilities, and associated software tools.

Communication between the host system and the MultiLINX Cable is dependent on host system capability. The following table lists the valid baud rates for the supported platforms.

Table 4-2 Valid Baud Rates

Baud Rates		
Cable	PC	WorkStation
MultiLINX Cable (USB)	1M-12M (Currently USB is supported only on Win98/95C.)	USB is currently not supported on the WorkStation.
MultiLINX Cable (RS-232)	9600, 19200, 38400, and 57600	9600, 19200, and 38400

XChecker Cable

You can use the XChecker Cable to download, verify, and debug. The XChecker Cable assembly houses the following internal circuitry.

Xilinx FPGA	Functions as an interface between the XChecker software and the target FPGA.
Static RAM	Stores the configuration data for download and readback.
Oscillator circuit	Provides a system clock to facilitate download and readback of configuration data.

The XChecker Cable requires a standard DB-9 or DB-25 RS-232 serial port and may require a DB9/DB25 adapter. The cable has 14 signal connections, plus VCC and GND. It comes with two header connectors and two flying lead connectors. The following figure shows top and bottom views of the cable.

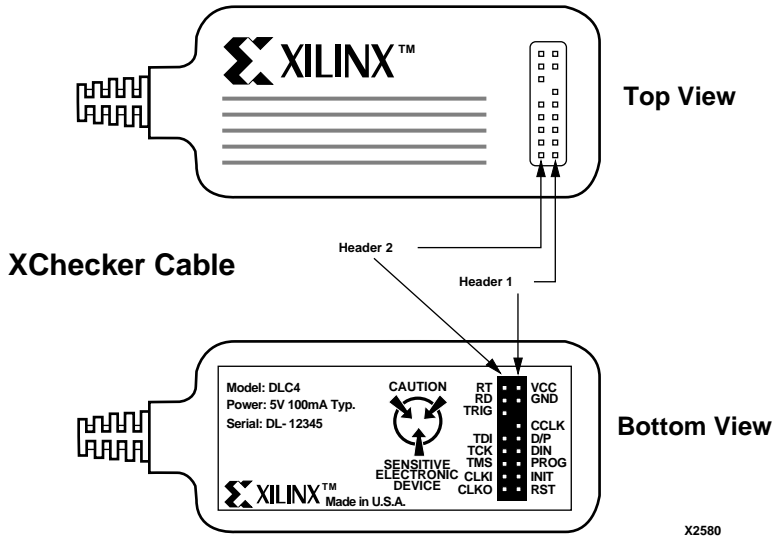

Figure 4-1 XChecker Cable

You can use the XChecker Cable with a single FPGA or several connected in a daisy chain to download configuration data. When used to read back data or as a logic probe, the XChecker Cable can only be used with one device at a time. The XChecker Cable transmits configuration data to all target FPGAs at 921 kHz.

Communication between the host system and the XChecker Cable is dependent on host system capability. The following table lists the valid baud rates for the supported platforms.

Table 4-3 Valid Baud Rates

Baud Rate				
Platform	9600	19200	38400	115200
Sun	X	X	X	
HP	X	X	X	X
PC	X	X	X	X

X indicates supported baud rate.

Additional XChecker Hardware

The XChecker hardware is the cable assembly with internal logic as described in the previous section, a test fixture, and a set of headers to connect the cable to your target system. In addition, a 3 V Adapter for use with low-voltage parts is available as optional equipment. The following figure shows the XChecker Cable hardware and accessories.

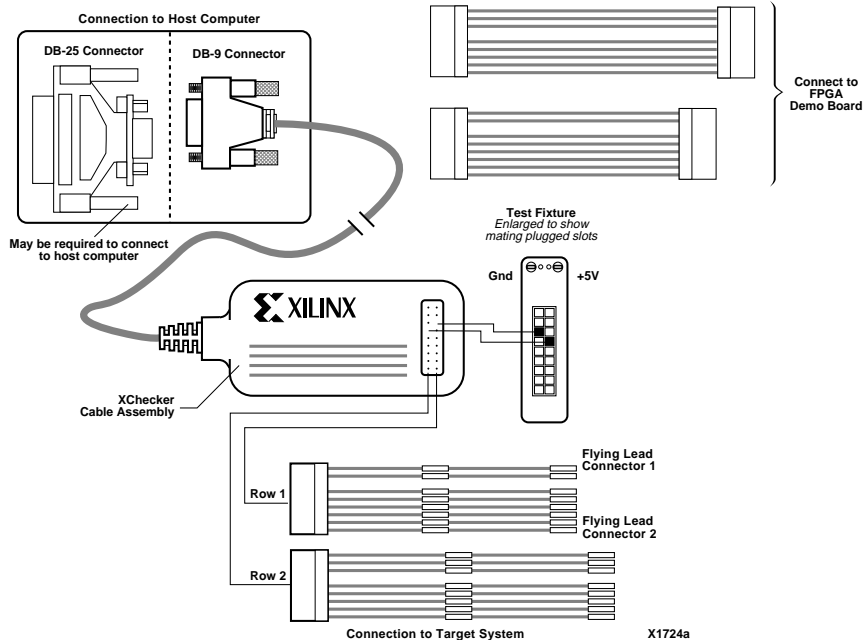

Figure 4-2 XChecker Hardware and Accessories

The optional 3 V adapter accepts VCC supply voltages from the target system from +2.9 V to +5.25 V. The 3 V adapter contains a voltage step-up circuit that generates the 5 V supply voltage needed by XChecker.

Because the 3 V adapter can accept input voltages up to 5.25 V, there is no need to remove the adapter when moving the XChecker Cable between low-voltage systems and higher 5 V systems. Except for the voltage conversion, the 3 V adapter is completely invisible to the XChecker hardware or the target system.

Parallel Cable

You can use a parallel cable to download configuration data. The Xilinx parallel cable has a 6-lead flying header connector with VCC, GND, CCLK, D/P, PROG, and DIN, and also includes a 25-pin male connector.

Note: The parallel cable is supported on the PC only.

Serial Cable

You can use a serial cable to download configuration data. This cable has a 6-lead header connector with VCC, GND, CCLK, D/P, PROG, and DIN, and also includes a female RS-232 serial connector.

Cable Limitations

The MultiLINX Cable should be compatible in supporting Readback & Verify for all the FPGAs supported by the XChecker Cable. In addition to the supported devices, the MultiLINX Cable will support the devices that were not supported by the XChecker Cable since the MultiLINX Cable has no RAM size limitations. These devices include those devices in 4000E, 4000XL, and SPARTAN whose bitfile size is more than 256K bits. The MultiLINX Cable will also support Readback & Verify functions in the new Virtex family.

XChecker Hardware Drawbacks

- Cannot support readback for devices whose bitfile size is more than 256K bits.
- Only supports RS-232.
- Has less user control (only 2 sets of 8 flying wires each).

MultiLINX Hardware Advantages

- Fast download, readback and debug using the USB port up to 12M bits/sec.
- More configuration modes are supported.
- Supports both RS-232 ports and USB ports.
- Compatible with the currently supported devices for Readback & Verify.
- Supports new devices that are not supported by XChecker due to RAM size limitation.
- Works at low voltages (3.3V).
- Supports both Slave Serial and SelectMAP configuration modes.

Cable Baud Rates

The supported Baud Rates for all four cables are shown in the following table.

Table 4-4 Cable Baud Rates

Cable	PC	WorkStation
MultiLINX Cable (USB)	1M-12M	USB is currently not supported on the WorkStation.
MultiLINX Cable (RS-232)	9600, 19200, 38400, and 57600	9600, 19200, and 38400
XChecker Cable	9600, 19200, 38400, and 115200	9600, 19200, and 38400
Serial Cable	9600, 19200, and 38400	9600, 19200, and 38400
Parallel Cable	9600	Not supported on the WorkStation.

Connecting Cable to Host System

To install the cable, you must first connect it to the host system.

MultiLINX Cable

If you have a MultiLINX Cable, connect it to the USB or RS-232 port. A DB-9/DB-25 adapter may be required to connect the cable to your serial port. If you have a different serial port connection, you need to use the appropriate adapter.

Parallel Cables

If you have a parallel cable, connect it to the parallel port.

Serial and XChecker Cables

Connect your serial or XChecker Cable to your system's RS-232 serial port. A DB-9/DB-25 adapter may be required to connect the cable to

your serial port. If you have a different serial port connection, you need to use the appropriate adapter.

Setting Up the Hardware

When using the MultiLINX Cable the default mode is slave serial. For PROM files and Virtex bitfiles, the Communication Setup dialog box will popup when download is attempted.

When using the XChecker, parallel, or serial cables you must set up the configuration mode of the devices being configured as slave serial. You must set M0, M1, and M2 to VCC. If you intend to use them as user I/Os, use 4.7 k Ω pull-ups. Refer to *Development System Reference Guide* and *The Programmable Logic Data Book* for information on how to set the mode pins.

Connecting Cable to Target System

This section covers cable connection to the target device. You need appropriate pins on the target system for connecting the target system board to the header connectors on the cable.

Warning: The cable draws its power from the target system through VCC and GND. Therefore, power to the cable, as well as to the target FPGA, must be stable. Do not connect any signals before connecting VCC and GND. The input/output pins of the internal XChecker FPGA should always be at a potential that is lower or equal to their respective rail voltage to avoid internal damage.

MultiLINX Cable Connectors

The MultiLINX Cable supports four types of flying lead connectors. For detailed information on the MultiLINX Flying Wires and cable modes refer to the “MultiLINX™ Cable” chapter of the *Hardware User Guide*.

XChecker Cable Connectors

The XChecker Cable supports two types of connectors. You can connect to the pins of your target FPGA with a flying lead connector and to the FPGA demonstration boards with a header connector.

- Flying lead header connectors have eight standard individual female connectors on one end that connect with 0.025 inch square male pins. Each lead is labeled to identify the pin.
- Header connectors are standard 9-pin (8 signals, 1 key) header connectors that fit 0.025 inch square male pins. The pin layout is shown in the “XChecker Cable” figure. The header connectors are keyed to ensure that they are properly inserted into the cable assembly.

Each type of connector, has two different subconnectors. One is keyed for downloading signals; the second is keyed for readback signals. Header 1 is the download subconnector and fits on the outer-most subconnector socket. Header 2 is the readback subconnector and fits on the inner subconnector socket.

XChecker Cable Pins

Refer to the tables in this section for information on how to connect the signal pins for specific applications. The “XChecker Operation Mode Connections” table shows the necessary connections for each application type, and the “Cable Connections and Definitions” table describes the pins and how to connect them.

Note: Not all of the signal pins are required for each function.

Table 4-5 XChecker Operation Mode Connections

Cable Header	Pin Name	Download	Verification	Synchronous Logic Probe	Asynchronous Logic Probe
1	VCC	X	X	X	X
1	GND	X	X	X	X
1	CCLK	X	X	X	X
1	D/P	X			
1	DIN	X			
1	PROG (XC4000 only)	X			
1	INIT (XC3000/ XC4000 only)	X			

Table 4-5 XChecker Operation Mode Connections

Cable Header	Pin Name	Download	Verification	Synchronous Logic Probe	Asynchronous Logic Probe
1	RST	Opt	Opt	Opt	Opt
2	RT		X	X	X
2	RD		X	X	X
2	TRIG			Opt	Opt
2	TDI				
2	TCK				
2	TMS				
2	CLKI			Opt	
2	CLKO			X	

X = Connect as specified in the “Cable Connections and Definitions” table.

Opt = Optional

Table 4-6 Cable Connections and Definitions

Signal Name	Function	XC3000	XC4000	XC5200
VCC	<i>Power</i> — Supplies VCC to cable (5 V, 100 mA, typically)	Connect to target system.		
GND	<i>Ground</i> — Supplies ground reference to cable	Connect to target system ground.		
CCLK	<i>Configuration Clock</i> — Provides configuration clock to target system during configuration and readback	Connect to target system Configuration Clock. Ensure all devices are in slave serial mode if using download cable to download.		
D/P	<i>Done/Program</i> — Signals the end of configuration (For XC3000 devices, a High-to-Low transition on D/P coupled with a High to Low on Reset, causes the device to reprogram.)	Connect to D/ \bar{P} pin with a 10-50 k Ω pull-up resistor.	Connect to target system DONE pin and rely on internal 2-8 k Ω pull-up resistors.	

Table 4-6 Cable Connections and Definitions

Signal Name	Function	XC3000	XC4000	XC5200
DIN	<i>Data In</i> — Provides configuration data to target system during configuration and is tristated at all other times	Connect to target system's lead device DIN pin.		
PROG (XC4000 Only)	<i>Program</i> — 300ns or greater Low pulse causes device to reprogram (A Low indicates the device is clearing its configuration memory.)	N/A	Connect to target system $\overline{\text{PROG}}$ with 10-50 k Ω pull-up resistor.	
INIT	<i>Initialize</i> — Indicates start of configuration for XC3000/XC4000 parts. A logical zero on this pin during configuration indicates a data error	Connect to target system INIT with a 10-50 k Ω pull-up resistor.		
RST	<i>Reset</i> — During configuration, a Low pulse causes XC3000A devices to restart configuration After configuration, this pin can drive Low to reset target FPGA internal latches and flip-flops RST is the active high for XC4000/XC5200 devices	Connect to target FPGA $\overline{\text{RESET}}$ pin with 10-50 k Ω pull-up resistor.	User-programmable connection; requires a 10-50 k Ω pull-up resistor	
RT	<i>Read Trigger</i> — XChecker output Hardware Debugger provides Low-to-High transition on RT to initiate readback	Connect to M0/RTRIG with 10-50 k Ω pull-up resistor.	User-programmable connection; requires 10-50 k Ω pull-up resistor	

Table 4-6 Cable Connections and Definitions

Signal Name	Function	XC3000	XC4000	XC5200
RD	<i>Read Data</i> — XChecker input Hardware Debugger receives the readback data through the RD pin after readback is initiated.	Connect to M1/ RDATA through pull-up resistor in slave serial configura- tion mode; requires a 10-50 k Ω pull-up resistor if using I/O pad as input or output	User-programmable connection; requires 10-50 k Ω pull-up resistor if using I/O pad as input or output	
TRIG	<i>System Trigger</i> — XChecker input High on this pin signals the XChecker electronics to initiate a readback and causes the RT pin to go High	Connect to target system readback trigger and to an external pin if using an external signal to trigger readback.		
TDI TCK TMS	Reserved (These pins can be used for JTAG Programmer device configuration.)	N/A		

Table 4-6 Cable Connections and Definitions

Signal Name	Function	XC3000	XC4000	XC5200
CLKI	<i>Clock Input</i> — Transmits your system clock to the XChecker electronics Clock must be between 120 kHz and 10 MHz Connect this pin to target system clock to synchronize the readback trigger with target system clock	Connect to source of target system clock for synchronous debugging.		
CLKO	<i>Clock Output</i> — Drives target system clock Clock can come from either the CLKI pin, or it can be internally generated by the XChecker Cable when CLKI is unconnected	Connect to destination of target system clock for synchronous debugging.		

Note: XChecker does not drive the configuration mode pins (M0, M1, M2) during configuration. You must specify the logic levels for these pins externally.

Serial and Parallel Cables

Connect all the pins of your serial or parallel cable for downloading using the guidelines in the “XChecker Operation Mode Connections” table and the “Cable Connections and Definitions” table.

Connecting the 3 Volt Adapter to the XChecker Cable

If you are using a 3 V target board instead of a 5 V target board, you must connect the 3 V adapter to the XChecker Cable. The 3 V adapter supports VCC supply voltages from your target system that range from 2.9 V to 5.25 V. An internal voltage “step-up” circuit generates the 5 V voltage supply needed by the XChecker Cable.

Aside from the voltage conversion, the 3 V adapter is completely transparent to the XChecker hardware and the target system. Therefore, you do not need to remove the 3 V adapter when moving the XChecker Cable between 3 V and 5 V systems.

The 3 V adapter includes the J1 and J2 connectors.

Note: For information on testing the operation of the 3 V adapter, see the “Testing 3 V Adapter Operation” section.

Connecting the 3 Volt Adapter

Follow these steps to connect the 3 V adapter to the XChecker Cable.

Warning: Use standard electrostatic discharge (ESD) precautions when connecting the adapter to your XChecker Cable. The adapter is static sensitive and can be damaged by ESD energy.

1. Ensure that you are adequately grounded before connecting or using the 3 V adapter.
2. Refer to the following figure to position the adapter on top of the XChecker assembly, aligning the adapter 18-pin female connector (J2) with the XChecker 18-pin male connector socket.

Ensure that the Xilinx logo on the XChecker case and the 3 V adapter silkscreen are oriented the same way.

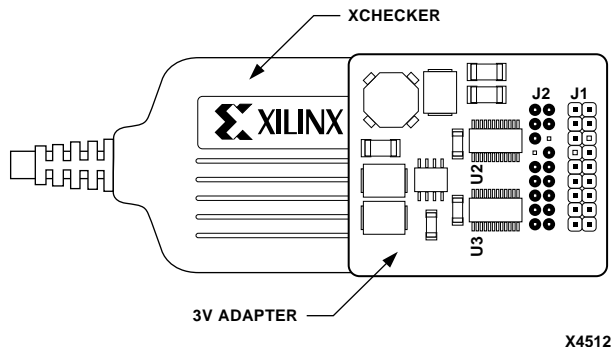

Figure 4-3 3 V Adapter Connected to XChecker Cable

3. Holding the adapter board by the edges, press it down until it makes a solid connection to the XChecker Cable.

Using the 3 Volt Adapter with XC3000L and XC4000XL Parts

To use the 3 V adapter with XC3000L and XC4000XL, follow these steps.

1. Attach the 18-signal flying wire or header block to the J1 connector on the 3 V adapter.
XChecker operation is unchanged.
2. Attach the XChecker Cable (with the 3 V adapter) to your target system.

The configuration of the XC3000L devices is the same as the XC3000, XC3000A, and XC3100 devices.

The readback clock speed of the XC3000L devices has been slowed because of lower VCC supply voltage. If the supply voltage of the target system is lower than 3 V, you might see an error message similar to the one shown below.

```
XCHECKER? verify
Design design_name has 128 probeable signals.
Readback 1847 bytes of configuration.
Verifying datafile design_name...MISMATCHED Total
of 405 bits mismatched.
```

Connecting for Download

To connect your cable for downloading only, connect your configuration cable to your target FPGA device. Refer to the “XChecker Operation Mode Connections” table and the “Cable Connections and Definitions” table for pin assignment information. The following figure shows the XChecker Cable connected for downloading only.

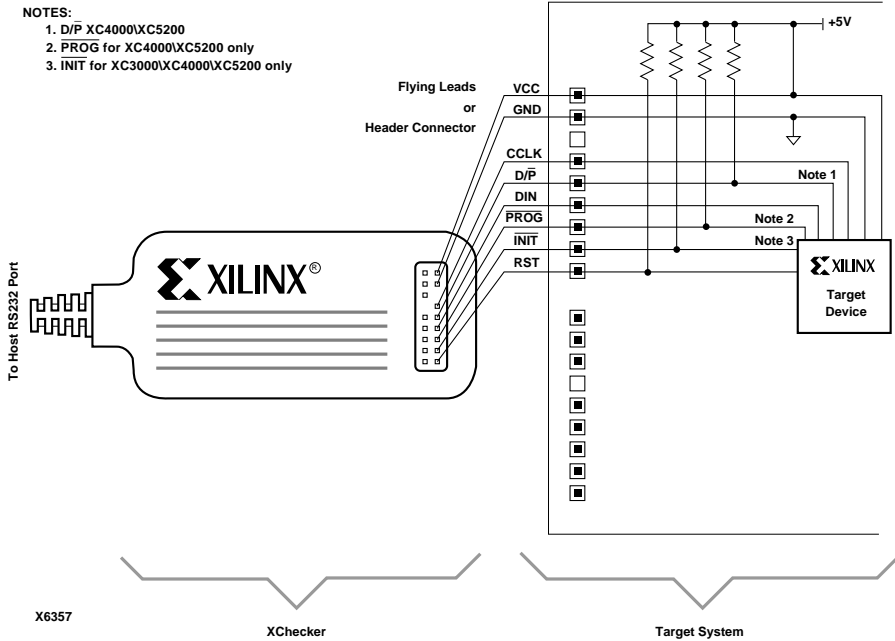

Figure 4-4 Downloading Configuration Data

Connecting for Verification

To connect your cable for downloading and verification, connect your XChecker Cable to your target FPGA as shown in the following figure. Refer to the “XChecker Operation Mode Connections” table for pin assignment information.

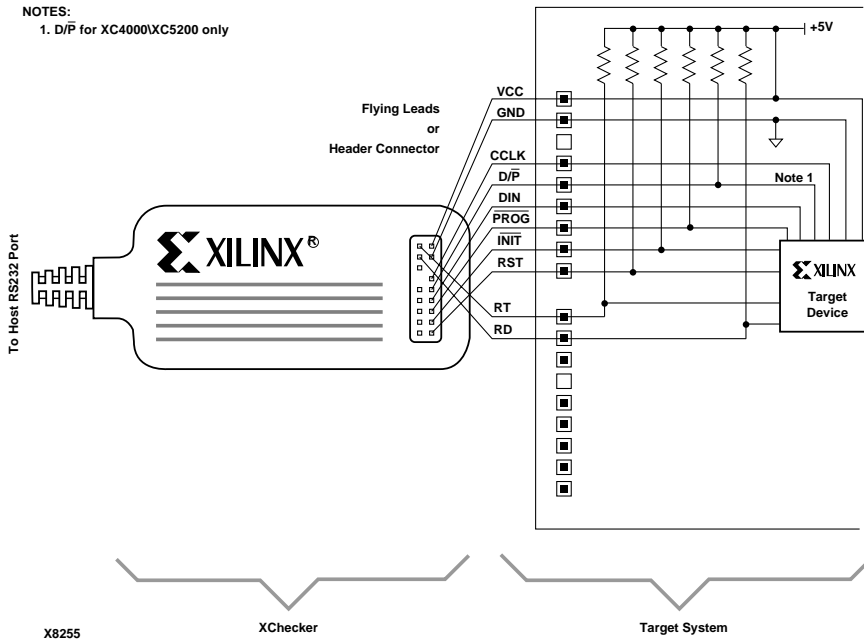

Figure 4-5 XChecker Cable Connections for Downloading and Verification

You can also use XChecker to verify a previously configured FPGA. To verify a previously configured FPGA, connect XChecker as shown in the following figure.

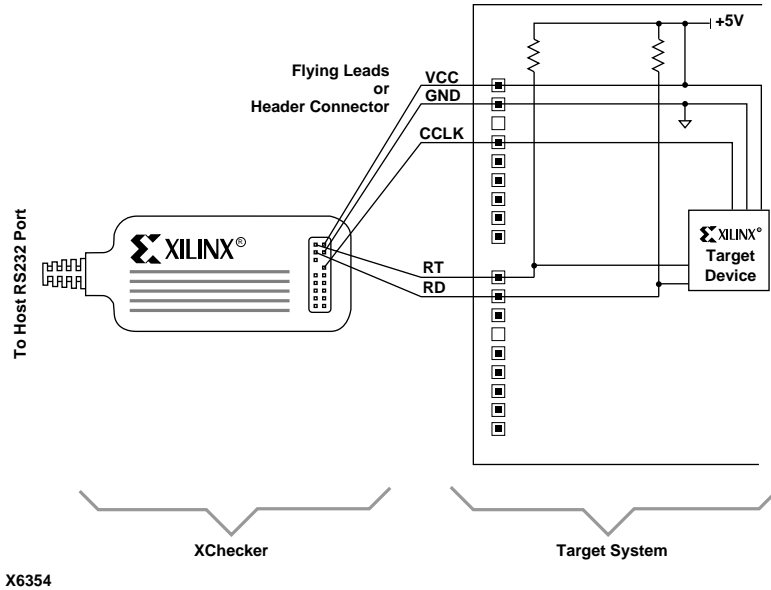

Figure 4-6 XChecker Cable Connections for Verification Only

Connecting RT and RD

Connect the XChecker RT and RD pins to the FPGA RTRIG and RDATA pins, respectively. If you used the symbols MD0 and MD1, consult the device pinout tables in *The Programmable Logic Data Book* for the exact locations of M0 and M1. If you used IPAD/OPAD primitives, consult *The Programmable Logic Data Book* for IPAD and OPAD listings or the I/O Pin Assignments Report available from the Design Manager's Report Browser.

Connecting for Synchronous Debugging

In synchronous mode debugging, you can control the target FPGA clock through the XChecker Cable. You can control the number of clock pulses applied and the frequency at which the clock cycles occur. For synchronous debugging, connect the TRIG, RT, RD, CLKO

and, optionally, CLKI pins of the XChecker Cable to the target FPGA, as shown in the “XChecker Operation Mode Connections” table and the “Cable Connections and Definitions” table. Also, refer to the following figure for connection information. This XChecker Cable configuration allows you to download, verify, and debug your design in the synchronous mode.

NOTES:

1. D/P for XC4000\XC5200
2. PROG for XC4000\XC5200 only

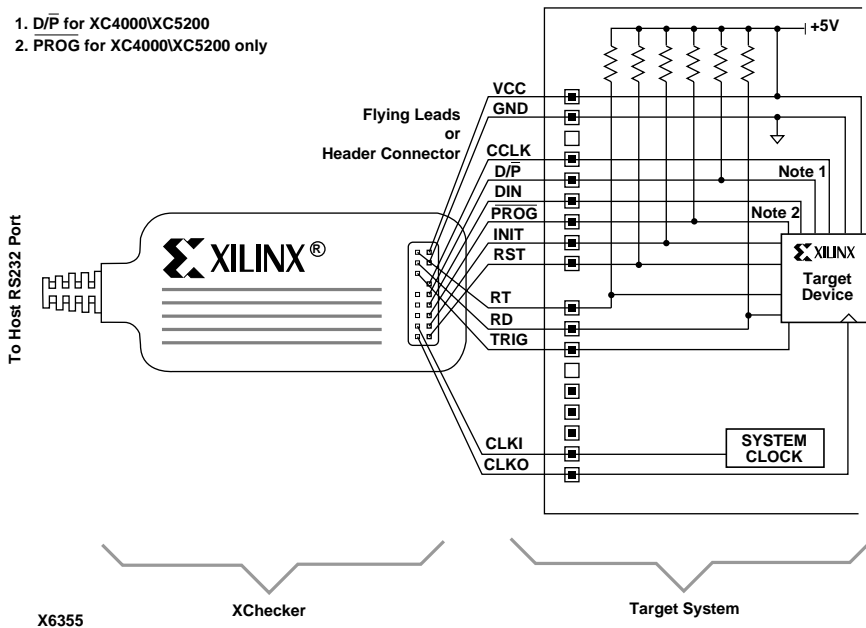

Figure 4-7 XChecker Cable Connections for Synchronous Debugging

Connecting the XChecker Clock

To allow the XChecker clock to control the target FPGA system clock, connect XChecker’s CLKO pin to the pin that you assigned as the FPGA’s clock pin. All the synchronous logic should be connected to this clock source for synchronous debugging.

The source of the CLKO clock signal is from an internally generated XChecker clock oscillator or from an external clock oscillator that you provide.

Internal Clock

To use the XChecker internal clock, connect the CLKO pin to the target FPGA. Leave the CLKI pin unconnected. Then, select the **Debug** → **Settings** → **CLKO Clock Source** command from the Hardware Debugger menus and select the **Use XChecker Clock** setting from CLKO Clock Settings dialog box.

External Clock

To use an external clock, connect the user clock to the XChecker CLKI pin and connect the XChecker CLKO pin to the FPGA. Then, select the **Debug** → **Settings** → **CLKO Clock Source** command and select the **Use CLKI** setting from CLKO Clock Settings dialog box.

Connecting an External Trigger

To use an external trigger, such as the terminal count of a counter or some other condition in your target board to initiate a readback, connect the external trigger signal to the XChecker TRIG pin. TRIG is active-High.

Note: You do not need the TRIG signal if you plan to use an internal trigger, such as the Enter key on the keyboard to initiate a readback.

Connecting RT and RD

Connect the XChecker RT and RD pins to the FPGA RTRIG and RDATA pins, respectively. If you used the symbols MD0 and MD1, consult the device pinout tables in *The Programmable Logic Data Book* for the exact locations of M0 and M1. If you used IPAD/OPAD primitives, consult the I/O Pin Assignments Report available from the Design Manager's Report Browser.

Connecting for Asynchronous Debugging

This configuration allows the target system to run while a readback is executed. You do not need to provide the system clock to XChecker, because readback is executed independently of the system clock.

Connect the system clock so that it controls the device flip-flops directly. Thus, the CLKI and CLKO pins on the XChecker Cable are not used for asynchronous debugging.

Connect the external trigger and the RD and RT pins as explained in the previous “Connecting for Synchronous Debugging” section. Also, refer to the following figure for connection information.

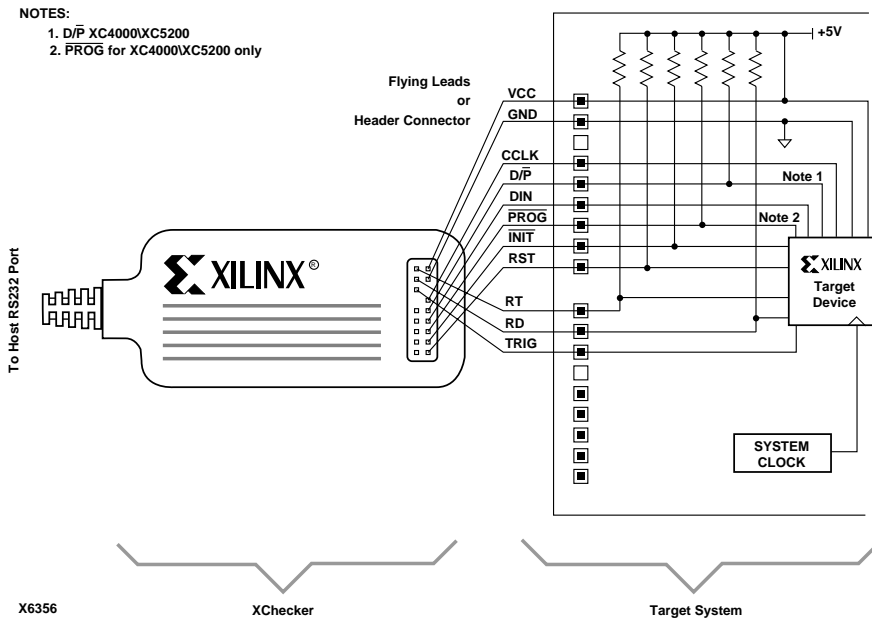

Figure 4-8 XChecker Cable Connections for Asynchronous Debugging

Setting the Cable Options

After connecting the cable to download, verify, or debug, power your target board to enable the software to communicate with the cable and start the Hardware Debugger. You must then set the cable options with the following steps.

1. Select **Cable** → **Communications** to display the Communication Setup dialog box, shown in the following figure.

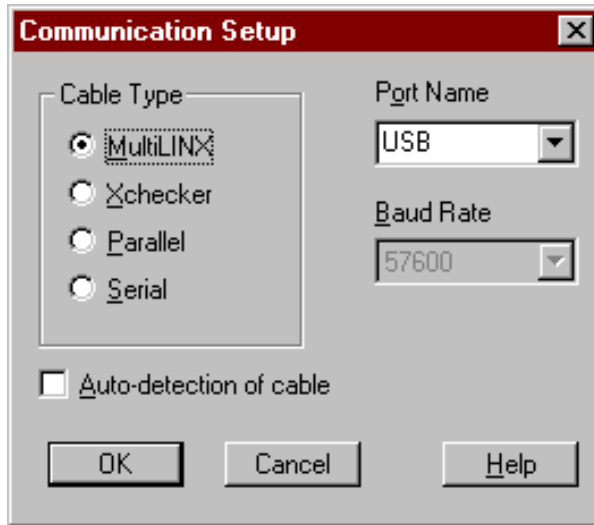

Figure 4-9 Communication Setup Dialog Box

2. In the Cable Type field, select the cable type that you installed for downloading. The Parallel Cable is supported for the PC only.
3. In the Port Name list box, select the port to use for downloading and readback. If the port name you want is not listed, select the blank name from the list box and type in the new port name. This list box saves up to two user-specified port names.

The Port Name list box contains a list of valid ports for the platform, as shown in the following table. If you selected the Multi-LINX Cable the USB port is displayed, If you selected a serial cable or an XChecker Cable, the serial ports are displayed. If you selected a parallel cable, the parallel ports are displayed.

Table 4-7 USB, Serial, and Parallel Ports

Platform	USB Ports	Serial Ports	Parallel Ports
Sol	none	/dev/ttya, /dev/ttyb	none
HP 10.x	none	/dev/tty0p0, /dev/tty1p0	none
PC	USB	com1, com2, com3, com4	lpt1, lpt2

4. In the Baud Rate list box, select a communications baud rate between the cable and the host system. You cannot specify the baud rate for a parallel cable.

Communication speed between the host system and the XChecker Cable depends on host system capability. Refer to the “Valid Baud Rates” table for a list of valid baud rates.

5. Select **Auto-detection of cable** if you want the software to scan for the presence of a cable and automatically establish communication. Cable information is presented in the status bar.
6. Click **OK** to accept the selections and close the dialog box.

Resetting the Cable

To reset internal logic of the cable after a power glitch select **Cable** → **Reset** to reset the internal logic of the cable. The cable is reinitialized and the proper baud rate is set.

Note: Reconfigure your target device if you experience a power failure to the target device board. This can be done by reconnecting to the cable. The Hardware Debugger reconfigures the cable FPGA if needed, after the connection is established.

MultiLINX Diagnostics

To test the MultiLINX Cable, bring up the MultiLINX Cable Self Check dialog box to perform a diagnostic of the cable.

Testing the MultiLINX Cable

The MultiLINX Cable contains special hardware for the readback of FPGA devices. To verify that the cable is in working order, follow these steps.

1. Attach the test fixture (provided with your MultiLINX Cable) to the MultiLINX Cable pins. The test fixture is a small printed circuit card with a keyed header connector that fits onto the MultiLINX Cable pins.
2. Start the Hardware Debugger software or, if the Hardware Debugger was running when you installed the test fixture, select **Cable** → **Reset** to establish communication with the cable.
3. Select **Cable** → **Self Check** to perform a diagnostic of the MultiLINX Cable.

The Cable Self Check dialog box, shown in the following figure is displayed.

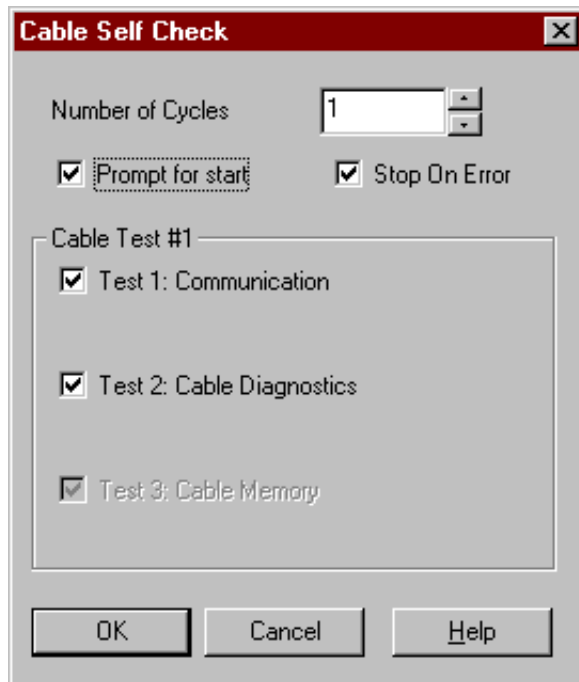

Figure 4-10 Cable Self Check Dialog Box (MultiLINX Cable)

4. Choose the appropriate settings in the dialog box, such as the number of cycles you want to run and types of tests you want to perform.
5. Click **OK** to start the diagnostic.

Note: The MultiLINX Cable does not have a separate cable self check test. The MultiLINX Cable does a BIST operation on power-up.

XChecker Diagnostics

XChecker includes a test fixture to test the XChecker Cable and 3 V adapter to support 3 V target boards.

Testing the XChecker Cable

The XChecker Cable contains special hardware for the readback of FPGA devices. To verify that the cable is in working order, follow these steps.

1. Attach the test fixture (provided with your XChecker Cable) to the XChecker Cable pins. The test fixture is a small printed circuit card with a keyed header connector that fits onto the XChecker Cable pins.
2. XChecker draws power from your target system, not from the host system. The test fixture has a red VCC power (+5 V) connector and a black ground connector. Plug these connectors to a 5 V DC power supply.
3. Start the Hardware Debugger software or, if the Hardware Debugger was running when you installed the test fixture, select **Cable** → **Reset** to establish communication with the cable.
4. Select **Cable** → **Self Check** to perform a diagnostic of the XChecker Cable.

The Cable Self Check dialog box, shown in the following figure is displayed.

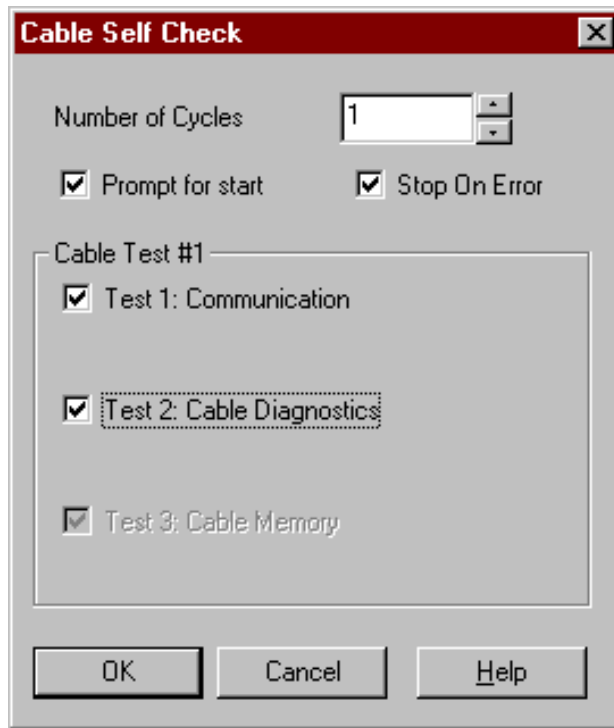

Figure 4-11 Cable Self Check Dialog Box (XChecker Cable)

5. Choose the appropriate settings in the dialog box, such as the number of cycles you want to run and types of tests you want to perform. For more information, see the “Cable Self Check Dialog Box” section of the “Menu Commands” chapter.

6. Click **OK** to start the diagnostic.

A dialog box appears with the following message.

“Connect cable and the test header, press OK to start.”

7. Click **OK**.

The output is displayed under each test name in the Cable Self Check dialog box. Overall test results are shown in the Cable Self Check (Results) dialog box. For information on test failures, refer

to the “Troubleshooting” section of the “Menu Commands” chapter.

Testing 3 V Adapter Operation

To test the operation of the 3 V adapter, use the test fixture that is shipped with the XChecker Cable, and follow these steps.

1. Plug the adapter into the XChecker case, as outlined in the “Connecting the 3 Volt Adapter to the XChecker Cable” section.
2. Plug the test fixture into the male connector (J1) of the adapter.
The test fixture is a small printed circuit card with a keyed header connector that fits onto the XChecker Cable pins.
3. XChecker draws power from your target system, not from the host system. The test fixture has two connectors: a red VCC power (+3 V) connector and a black ground connector. Plug these connectors to a 3 V DC power supply.
4. Start the Hardware Debugger software or, if the Hardware Debugger was running when you installed the test fixture, select **Cable** → **Reset** to establish communication with the cable.
5. Select **Cable** → **Self Check** from the menu to perform a diagnostic of the XChecker Cable.
6. Click **OK** to start the diagnostic.

This command runs the diagnostics test. The test should produce results that match those obtained by running the same diagnostics test without the 3 V adapter connected to XChecker.

Note: The readback clock speed of the XC3000L devices has been slowed because of lower VCC supply voltage.

If the supply voltage of the target system is lower than 3 V, you might see an error message similar to the one shown below.

```
Design design_name has 128 probeable signals.  
Readback 1847 bytes of configuration.  
Verifying datafile design_name...MISMATCHED  
Total of 405 bits mismatched.
```

If this occurs, correct the system voltage and download the design again.

Troubleshooting the MultiLINX Cable

This section includes solutions to some common problems you might encounter when configuring FPGAs with the MultiLINX Cable.

Warning: Connecting the MultiLINX leads to the wrong signal will cause permanent damage to MultiLINX internal hardware. You must connect PWR and GND to ground.

Troubleshooting the XChecker Cable

This section includes solutions to some common problems you might encounter when configuring FPGAs with the XChecker Cable.

Improper Connections

Warning: Connecting the XChecker leads to the wrong signal will cause permanent damage to XChecker internal hardware. You must connect VCC to +5 V and GND to ground.

Always make sure that XChecker leads are connected properly for the specified mode of operation. Refer to the “Cable Connections and Definitions” table and the “XChecker Operation Mode Connections” table. Use the Cable → Logic Level of Pins command to display the logic state of the leads. This helps determine connectivity between the target system and the XChecker Cable.

For workstations (applies to Sun only), you must have read and write permissions for the port to which you connect the XChecker Cable. XChecker might issue a message stating that the cable is not connected to port ttyx. If you see this message, follow this check list.

1. The board must have the power on because XChecker uses power from the board.
2. Check the device driver with the following command string.

```
ls -l /dev/ttya /dev/ttyb
```

The result should be the following.

```
crw-rw-rw-  1 root 12,0  month date time /dev/ttya
```

```
crw-rw-rw- 1 root12,1 month date time /dev/ttyb
```

3. Reconnect the XChecker Cable to another valid port.
4. Read the /etc/ttyab file. There should be two lines, as follows.

```
ttya"/usr/etc/getty std.9600" unknown off  
local secure  
  
ttyb"/usr/etc/getty std.9600" unknown off  
local secure
```

If you use a port to connect a modem for a remote login, you cannot use that port. The port must be on. Consult your System Administrator if the information the /etc/ttyab file differs from what is listed in the previous list.

Improper or Unstable VCC

Warning: As with any CMOS device, the input/output pins of the internal FPGA should always be at a lower or equal potential than the rail voltage to avoid internal damage.

Never connect the control signals to XChecker before VCC and ground are connected. Xilinx recommends the following sequence.

1. Turn off power to the target system.
2. Connect VCC, ground, and then the signal leads.
3. Turn on power to the target system.

Make sure VCC rises to a stable level within 10ms. After VCC stabilizes, the level should be between 4.75 V and 5.25 V.

In the event of power glitches, reset the cable with the Cable → Reset command to reconfigure the XChecker internal FPGA device and then reconfigure the target device. For more information, see the “Resetting the Cable” section.

Programming a Device or a Daisy Chain

The Hardware Debugger enables you to program the logic of a device. This chapter explains how to use the Download menu commands to configure one or more devices. It contains the following sections.

- “Downloading Basics”
- “Preparing for Download and Verification”
- “Opening a Design File”
- “Downloading to a Target Board”
- “Verifying Design Logic”
- “Downloading and Verifying a Design”
- “Configuring Multiple Devices”

Downloading Basics

Downloading is the process of programming a target device with the logic functions contained in your design. Verification is the process of reading back the downloaded configuration data and comparing it to the original data to ensure data was downloaded correctly.

Before beginning downloading or verification, turn on the power to your board.

Warning: You must connect VCC and ground before you connect the control signals to the MultiLINX Cable and the XChecker Cable. The input/output pins of their internal FPGA should always be at a potential that is lower or equal to their respective rail voltage in order to avoid internal damage.

Preparing for Download and Verification

When you start the Hardware Debugger, the cable you installed is automatically detected. To modify the Communications settings, refer to the “Setting the Cable Options” section of the “Connecting Your Cable” chapter.

Checking the Logic Level of Pins

The Logic Level of Pins command allows you to use the MultiLINX Cable and the XChecker Cable to display the logic levels of the cable pins and to probe digital signals on your board. It indicates the 1 or 0 value on each pin.

Steps 1 & 2 are specifically for the XChecker Cable, they are not needed for the MultiLINX Cable. For the MultiLINX Cable just connect the flying wires to the probe pins. There is no test header for the MultiLINX Cable.

Warning: Do not connect the XChecker leads to signals of different voltage levels than required to prevent damage to the XChecker internal hardware.

1. Connect the flying lead or header connector to the XChecker cable.
2. Attach the flying lead or header connectors to the pins or probe points.
3. Select **Cable** → **Logic Level of Pins**.

Before configuration, the following should be true: INIT=1, PROG=1, D/P=0, CCLK=1, and DIN=1.

4. Select **Scan Status Constantly** if you want the software to continually scan and update the status of the cable pins.
5. If necessary, make changes to the pin configuration.

Opening a Design File

After powering your target board, starting the Hardware Debugger, and setting the cable options, you are ready to open and download a design file. You can open BIT, RBT, or PROM files. You must open a BIT file if you want to verify and debug.

- BIT files and RBT files contain data for a single device. Use the Design Manager to create them.
- PROM files (.mcs, .tek, or .exo) contain data to program daisy chains. Use the PROM File Formatter to create them.
- Use the File → Open → Project command to open an existing project file (*design_name.xck*) that contains your design file.

Note: For byte wide PROMs greater than 0xFFFF (for example, 64k bytes) if the PROM start address is at an odd byte such as 0xFF, the resulting PROM cannot be used as an input design file in the Hardware Debugger for programming a FPGA device. Use either start address zero or one, starting at even bytes such as 0x10, 0x100 and so on while creating a PROM file.

1. Select **File** → **New** → **Project** or click the following toolbar button.



The New Project dialog box appears.

2. In the Directories list box, select the desired directory.
3. In the List Files of Type field, specify the extension for the type of file you want to open.

This extension is then displayed in the File Name list box. Only the files that match this extension are displayed in the File Name box.

4. In the File Name field, type the name of the design file you want to open or click on the file name in the File Name list box.
5. Click **OK**.

If you do not have a logic allocation file (*design_name.ll*), a popup dialog box appears, informing you that debugging is not possible. The *design_name.ll* file is created during the implementation process if you have selected the appropriate readback option. Click **OK** to proceed.

After you choose a file to open, a project window appears that shows the hierarchical structure of files for each project. Each project contains bitstream, macro, and waveform data. The device name is only included in this hierarchy when you open a BIT file.

Downloading to a Target Board

After you set up the appropriate cable and open a file to download, you can download the configuration data to a target board.

Note: If you plan to verify or debug a design, download a BIT file. You cannot verify or debug PROM files or RBT files. For more information, see the “Design Preparation” chapter.

1. Select **Download** → **Download Design** or click the following toolbar button.



A download status window appears. This window includes a status bar that is updated as the data blocks are transmitted.

2. If the design is downloaded successfully, a message appears informing you that the device is configured and provides you with the transmission time.

Verifying Design Logic

The Verify Bitstream command verifies a design that you downloaded using a BIT file. To verify or debug a device, meet the following criteria.

- Use a BIT file as input.
- Generate a logic allocation (*design_name.ll*) file in the design directory by doing one of the following.
 - Use the `-l` option in BitGen.
 - Enable the readback option as specified in the “Design Preparation” chapter.

- Use the `-in` option for the Virtex family also with BitGen to generate a mask (*design_name.msk*) file.
- If you have an XC4000 or XC5200 design, do the following.
 - Set the readback clock to CClk.
 - Include the READBACK symbol in your design.
 - Include the STARTUP symbol with an inverter on the RESET pin if you plan to reset your design using the Pulse /RESET button located on the Debug Control Panel.

- Use the XChecker Cable.

The XChecker must be configured for verification or debugging. Refer to the “XChecker Operation Mode Connections” table and the “Cable Connections and Definitions” table in the “Connecting Your Cable” chapter for information.

- Use the MultiLINX Cable.

The MultiLINX Cable must be configured only for download and verify. Refer to the “MultiLINX Device Configuration Modes” table in the “MultiLINX™ Cable” chapter of the *Hardware User Guide*.

During verification, the XChecker cable reads the configuration data from the connected FPGA and verifies that it is the same as the downloaded configuration data. To verify your design logic follow these steps.

1. Select **Download** → **Verify Bitstream** or click the following toolbar button.



The device’s configuration is read back and compared to the downloaded data to ensure that the device was properly configured.

2. When verification is completed, a message lets you know whether verification succeeded or failed. If verification failed, the message also informs you of the number of mismatched bits.

Downloading and Verifying a Design

To verify a device, the design and the XChecker cable must meet the conditions described in the preceding section. To download and verify your design follow these steps.

1. Select **File** → **Open** → **Project** and open a project that contains a BIT file.
2. Select **Download** → **Download and Verify** or click the following toolbar button.



3. When verification is complete, a message lets you know whether verification succeeded or failed. If verification failed, the message provides the number of mismatched bits.

Configuring Multiple Devices

You can use a PROM file to program several FPGAs at once.

Configuring a Daisy Chain of Devices

To configure a daisy chain of devices, connect the XChecker cable to the lead device and ensure that all the devices in the daisy chain are connected correctly.

1. Connect the device pins of the master device as specified for the operation you want. Follow these steps.
2. Connect the DOUT output of each slave device to the DIN input of the next device in the chain. Refer to *The Programmable Logic Data Book* for more information on how to connect devices in a daisy chain.
3. Select **File** → **Open** → **Project** to open a project that contains a PROM file.
4. Select **Download** → **Download Design** or click the following toolbar button.



The Download Status window appears with a status bar that is updated as the data blocks are transmitted.

5. If the design is downloaded successfully, a message appears informing you that the device is configured.

Verifying Individual Devices in a Daisy Chain

The Hardware Debugger and XChecker cable cannot read back or verify a daisy chain of FPGA devices. They can only read back and verify individual devices in a daisy chain.

To verify a device, the design must meet the conditions described in the “Verifying Design Logic” section. To verify an individual device, follow these steps.

1. Connect the XChecker cable directly to the readback pins of the device you want to verify.
2. Select **File** → **Open** → **Project** to open a project that contains a BIT file.
3. Select **Download** → **Verify Bitstream** or click the following toolbar button.



4. When verification is complete, a message lets you know whether verification succeeded or failed. If verification failed, the message provides the number of mismatched bits.

Debugging a Device

This chapter explains how to debug a configured FPGA in either synchronous or asynchronous mode and how to save the readback data in a file. It contains the following sections.

- “Debugging Basics”
- “Debugging a Configured FPGA”
- “Synchronous Mode Debugging”
- “Asynchronous Mode Debugging”
- “Creating and Modifying a Signal Group”
- “Creating and Modifying a Signal List”
- “Saving and Loading Readback Data”

Debugging Basics

Debugging refers to the process of reading back the internal states of a configured device using an XChecker Cable to ensure that the device is functioning as expected. After simulating a design to test it using worst-case delays, debug the device to analyze its in-circuit real-time behavior.

Note: The MultiLINX Cable does not currently support debug.

Debugging a Configured FPGA

After configuring a device, you can analyze its behavior by taking snapshots of the device’s probe points. Flip-flops, RAMs, CLB outputs, and IOBs are all probe points and are read back when a snapshot of the device is taken. See the “Probe Points in FPGA Devices” table of the “Introduction” chapter for more information.

The two debugging modes for capturing the states of a device are synchronous and asynchronous.

Synchronous

During synchronous debugging, the XChecker Cable is used to control your system clock and the state of your design. This allows you to probe the internal nodes at states that are known and stable. To control the clock, you can use the XChecker internal clock, as opposed to a system clock or a device clock. The XChecker Cable can also interface with a system clock, enabling you to start and stop the clock.

Asynchronous

During asynchronous debugging, the Hardware Debugger does not control the clock and therefore does not control which states are captured. Use asynchronous debugging if you have an onboard microprocessor or equivalent device that allows you to control the state of your FPGA.

Note: If the state is not static when the internal nodes are probed, the values on some probes may reflect one state while values on other nodes may reflect a later state. This occurs because the values of the nodes can change during the time it takes for probing.

Debugging Overview

This section summarizes the debugging process. For more details, continue with the “Synchronous Mode Debugging” section or the “Asynchronous Mode Debugging” section. To perform debugging, you must meet the criteria for verification and debugging listed in the “Verifying Design Logic” section of the “Programming a Device or a Daisy Chain” chapter.

After you download a BIT file using the Download → Download Design command, you can read back the states of the configured device using the Debug menu commands, as described in the following steps.

1. Choose a debugging mode by selecting either **Debug → Synchronous Mode** or **Debug → Asynchronous Mode**.

2. Set the appropriate options, such as the trigger type, the signals to display, and, in the case of synchronous debugging, the clock options, using the **Debug** → **Settings** submenu.

For more information on the commands in this submenu, see the “Menu Commands” chapter.

3. Open a new waveform window by selecting **File** → **New** → **Waveform**.
4. Click **Display** to select the signals for display.
5. Click **Read** to read the signals that you selected for display.

The signals are displayed in the active waveform window.

Debugging a Previously Debugged Design

To debug a previously debugged design, specify the debug mode after opening the design. The Hardware Debugger loads the relevant settings for the specified debugging mode. The data, summarized in the following table, is saved in your project file, *design_name.xck*.

Table 6-1 Available Synchronous and Asynchronous Settings

Settings	Synchronous Mode	Asynchronous Mode
Trigger	X	X
Number of clock cycles before and between snapshots	X	
Timeout	X	X
Reset before read-back	X	X
Clock	X	
Number of clocks	X	
Snapshots	X	
Groups and their radix settings	X	X
Displayed signals	X	X

Synchronous Mode Debugging

You must first download your design before you can debug it. The synchronous mode requires, the XChecker Cable, to conduct a controlled readback of your design. In this debug mode, you control the clock through the XChecker Cable.

The snapshot and clock features, which are available when performing synchronous mode debugging, enable you to define specific clock patterns to gather the device states you want. For example, if you are debugging a counter, you may want to check that the combinational values generate the state value of 10. Set the Number of Clocks Before First Snapshot to 10 and the number of snapshots to 1 to capture state 10 of the device.

In addition, you can use the following options.

- **Start Clock**
This option establishes a free-running clock on the CLKO pin and advances the states of the device forward.
- **Stop Clock**
This option stops the clock being applied on the CLKO pin.
- **Reset FPGA**
This option uses an active-Low pulse to set the device to its initial state.
- **Apply CLKO Clock(s)**
This option moves the device forward the number of states set by the Number of CLKO Clocks to Apply option.

Pin Assignments

Before using the synchronous mode, choose whether you want to use an internal XChecker clock or an external clock connected to the XChecker CLKI pin.

- To use the internal XChecker clock, connect the CLKO pin to the FPGA system clock input pin in place of an oscillator, and leave the CLKI pin unconnected.

- To use an external CLKI clock, connect the system clock to the XChecker CLKI pin and connect the XChecker CLKO pin to the FPGA system clock input pin.

Debugging in Synchronous Mode

To debug in synchronous mode, follow these steps.

1. Select **Debug** → **Synchronous Mode** or click the following toolbar button.



The **Debug** → **Settings** commands and the **Debug Control Panel** options, shown in the following figure, are set for synchronous debugging.

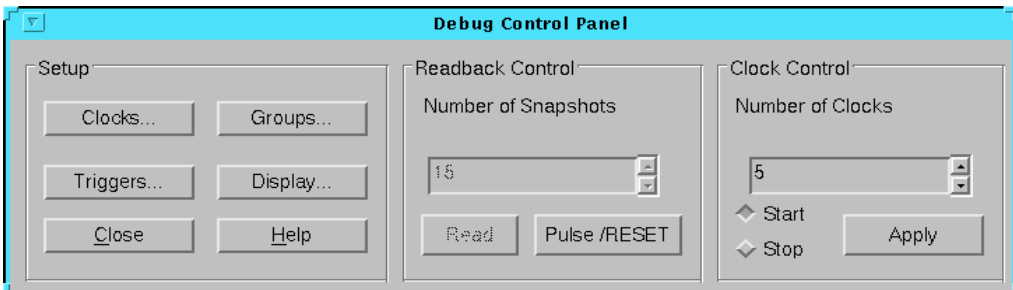

Figure 6-1 Debug Control Panel (Synchronous Mode)

2. Select **Debug** → **Settings** → **CLKO Clock Source** or click the **Clocks** button in the **Debug Control Panel**.

The **CLKO Clock Settings** dialog box appears as shown in the following figure.

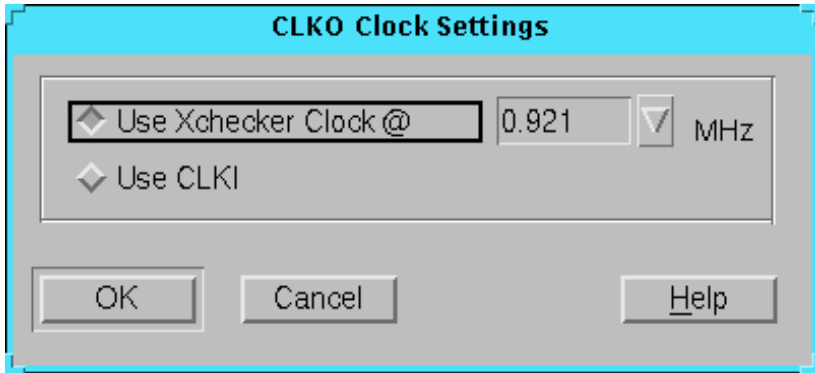

Figure 6-2 CLKO Clock Settings Dialog Box

3. Click the appropriate radio button for the clock you want to use: **Use MultiLINX Clock**, **Use CLKI-IN** or **Use CLK2-IN**.

- If you select the XChecker Clock, set the clock frequency to 0.921, 2.764, 5.529, or 11.059 MHz.
- If you select the CLKI clock, the FPGA uses the system clock connected to the XChecker CLKI pin. In this case, you cannot set the clock speed. The list box for the clock frequency is disabled.

4. After setting the desired clock settings, click **OK**.

The CLKO Clock Settings dialog box closes and the status bar displays the clock settings.

5. Select **Debug** → **Settings** → **Trigger** or click the **Trigger** button in the Debug Control Panel.

The Synchronous Trigger Settings dialog box appears, as shown in the following figure. You can select the type of trigger you want to initiate the readback.

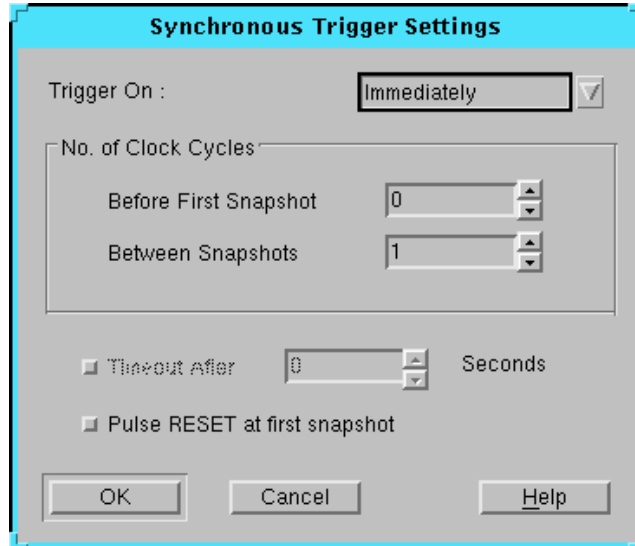

Figure 6-3 Synchronous Trigger Settings Dialog Box

6. In the **Trigger On** list box, select **External** pin (active-High on the TRIG pin of the XChecker Cable) or **Enter Key** to initiate a readback, or you can initiate a readback **Immediately** after the Read Snapshots command is executed.
7. In the **Number of Clock Cycles** field, specify the number of clock cycles to apply before the first snapshot and between snapshots. Use these options to cycle the device before the first snapshot and between multiple snapshots.
8. Use the **Timeout After** option to specify the cutoff time for trigger detection. If the trigger is not received within the specified time, the readback is canceled.
9. Select **Pulse RESET at First Snapshot** to reset the device each time you execute the Read Snapshots command.
10. After setting the desired trigger settings, click **OK**.
The Synchronous Trigger Settings dialog box closes and the status bar displays the Trigger settings.
11. Select **Debug** → **Settings** → **Display Signals** or click the **Display** button in the Debug Control Panel to choose the signals and groups that you want to display.

For details on how to select signals for display, see the “Creating and Modifying a Signal List” section in this chapter.

12. Select **Debug** → **Settings** → **Number of Snapshots to Read** or type a number in the **Number of Snapshots** field in the Debug Control Panel.

The Snapshots Count dialog box appears, as shown in the “Snapshots Count Dialog Box” figure, allowing you to enter the number of snapshots to read.

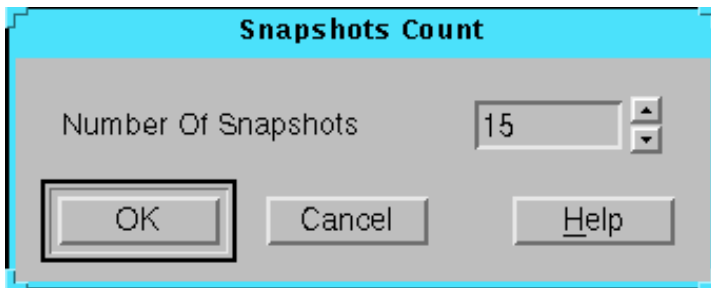

Figure 6-4 Snapshots Count Dialog Box

13. Enter the number of snapshots. Click **OK**.

The Snapshots Count dialog box closes and the status bar displays the number of snapshots.

14. Select **Debug** → **Read Snapshots** or click **Read** in the Debug Control Panel to read the states of the signals that you selected for debugging.

The device being read back returns its configuration data and the state of every probe point when a readback is triggered.

The software then extracts the signals you selected and displays the signal values in a waveform, as shown in the following figure.

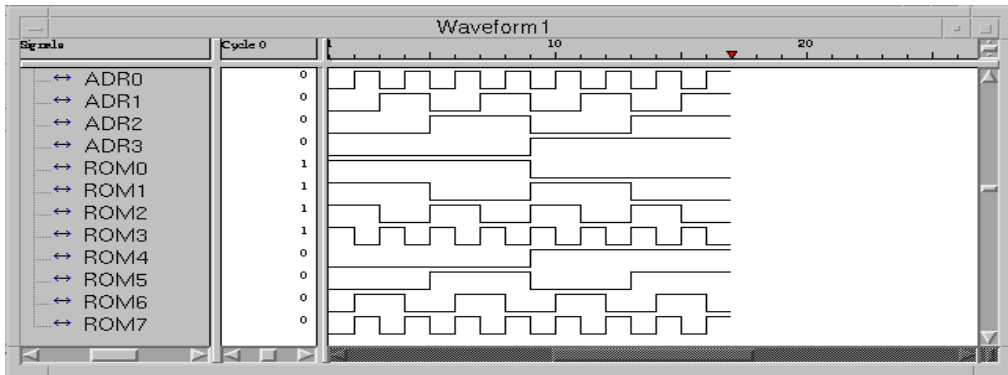

Figure 6-5 Waveform Window

Note: The readback data stream is linked to the active waveform window only. After the connection is closed, the waveform window is not updated with new information.

Cycling the Device

You can control the clock through the XChecker Cable by applying a specific number of clocks to the device. When you apply clocks to your device, you advance the state of your device.

Follow these steps to apply Clocks to your device.

1. Select **Debug** → **Settings** → **Number of CLKO Clocks to Apply** and enter the number of clocks to apply or type a number in the **Number of Clocks** field in the Debug Control Panel.
2. Select **Debug** → **Apply CLKO Clock(s)** to cycle the device the number of clocks specified in the Number of Clocks to Apply field. Alternatively, you can click **Apply** in the Debug Control Panel.

Note: When the number of clocks to apply is set to 1, the Apply Clocks command can be used to single step the device during synchronous debugging.

Resetting the FPGA

If you have not set the Pulse RESET at First Snapshot option in the Trigger Settings dialog box, choose **Debug** → **Reset FPGA** to issue an active-Low reset before issuing the Read Snapshots command.

Viewing Additional Signals

Follow these steps to view new signals on your waveform, you must add these signals to the display list and read the device states again.

1. Use the **Debug** → **Settings** → **Display Signals** command or click **Display** in the Debug Control Panel to add new signals to the display list.
2. In the Display Signals dialog box, add the new signals to the display.
3. Click **OK**.
4. Select **Debug** → **Read Snapshots** to read the states of the new signals.

Viewing the Waveform in Text Mode

Select **View** → **Text Data** to display the snapshots in textual form.

Asynchronous Mode Debugging

Asynchronous mode debugging allows you to use any external clock. Because the XChecker Cable does not control the system clock, any number of clocks can occur between snapshots; and all snapshots are asynchronous to the system clock.

Pin Assignments

In asynchronous mode, leave the XChecker CLKI and CLKO pins unconnected since you do not use the XChecker Cable to control the clock. Instead, you use an oscillator to drive the FPGA system clock directly. Connect the system clock so that it controls the target device flip-flops directly.

Debugging in the Asynchronous Mode

In asynchronous mode debugging, you use a free-running clock to cycle the device as described in the following steps.

1. Select **Debug** → **Asynchronous Mode** or click the following toolbar button.



The **Debug** → **Settings** commands and the **Debug Control Panel** options, shown in the following figure, are used for asynchronous debugging.

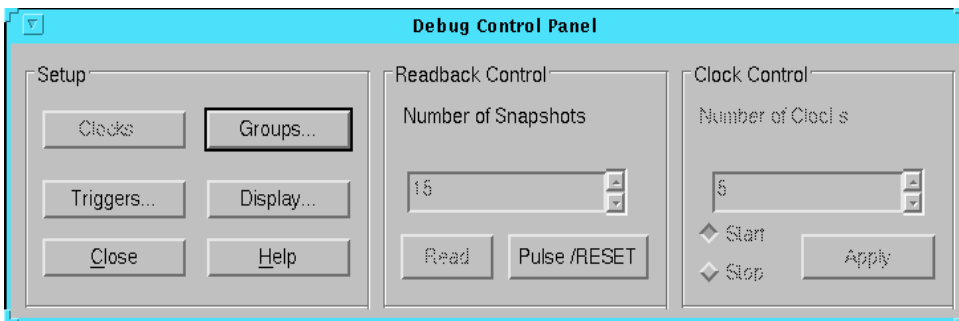

Figure 6-6 Debug Control Panel (Asynchronous Mode)

Note: Because the Hardware Debugger does not control the system clock, the clock settings are disabled.

2. Select **Debug** → **Settings** → **Trigger** or click the **Triggers** button in the **Debug Control Panel**.

The **Trigger** command invokes the **Asynchronous Trigger Settings** dialog box, shown in the following figure, which enables you to select the type of trigger you want to initiate the readback.

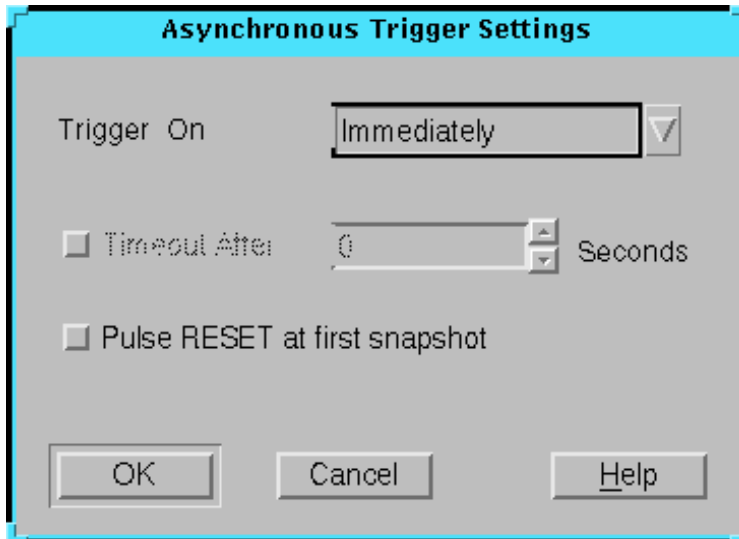

Figure 6-7 Asynchronous Trigger Settings Dialog Box

3. In the **Trigger On** list box, select **External** pin (active-High on the TRIG pin of the XChecker Cable) or **Enter Key** to initiate a readback, or you can initiate a readback **Immediately** after the Read Snapshots command is invoked.
4. Use the **Timeout After** option to specify the cutoff time for a trigger to be detected. If the trigger is not received within the specified time, the readback is canceled.
5. Select **Pulse RESET at First Snapshot** to reset the device each time you execute the Read Snapshots command.
6. After setting the desired trigger settings, click **OK**.

The Asynchronous Trigger Settings dialog box closes and the status bar displays the Trigger settings.

7. Select **Debug** → **Settings** → **Display Signals** or click **Display** in the Debug Control Panel to choose the signals and groups that you want to display.

For details on how to select signals for display, see the “Creating and Modifying a Signal List” section in this chapter.

8. Select **Debug** → **Reset FPGA** or click **Pulse /RESET** on the Debug Control Panel whenever you need to reinitialize the device.
9. Select **Debug** → **Read Snapshots** to read the states of the signals that you selected for debugging or click **Read** in the Debug Control Panel.

The device being read back returns its configuration data and the state of every probe point when a readback is triggered.

Note: The readback data stream is linked to the active waveform window only. After the connection is closed, the waveform window is not updated with new information.

Creating and Modifying a Signal Group

Use the **Debug** → **Settings** → **Signal Groups** command to create a group of signals or to add or remove signals from a previously defined group of signals. Use this option in conjunction with the **Debug** → **Settings** → **Display Signals** command when you are in the process of debugging a design.

Creating a Signal Group

Follow this procedure to create a signal group.

1. Select **Debug** → **Settings** → **Signal Groups**.

The **Signal Groups** command invokes the **Signal Groups** dialog box, shown in the following figure, which enables you to select the signal groups that you want to probe.

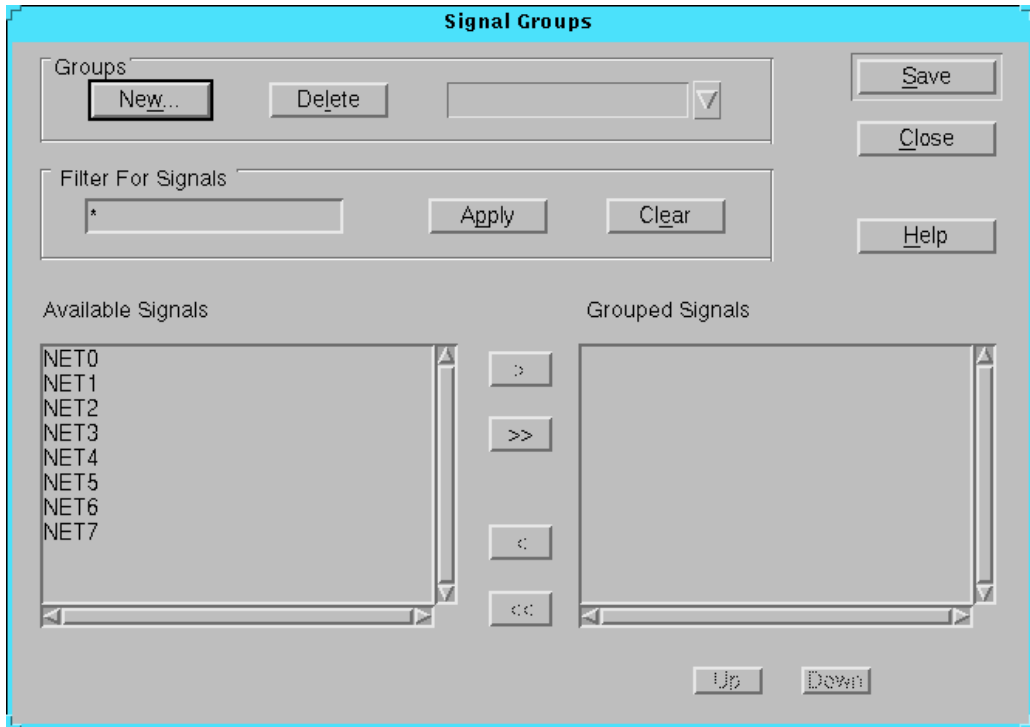

Figure 6-8 Signal Groups Dialog Box

2. Click **New**.
3. Type the name of the group you want to create in the Name field of the Group Name popup dialog box.
4. Use the Filter For Signals field to filter the signal names and make signal selection easier. For example, if you specify the letter A followed by a wildcard (*) all signal names that start with “A” are filtered.

Click **Apply** to apply the filter to the signals displayed in the Available Signals list box. To redisplay the complete signal list, click **Clear**.

5. Select the signals you want to include in the group by highlighting the desired signals in the Available Signals list box and selecting the > button to move the highlighted signals to the Grouped Signals list box.

To remove signals from the Grouped Signals list box, select the signals and click the < button.

To add or remove all the signals displayed in a list box, use the << or >> button.

To rearrange the order of the signals displayed in the Grouped Signals list box, use the **Up** and **Down** buttons below the list box.

6. Click **save** to save the new group.
7. Click **Close** to exit the Signal Groups window.
8. Refer to the “Creating and Modifying a Signal List” section for information on how to include the groups you created in your display list.

Modifying a Signal Group

The Signal Groups dialog box contains a list of previously defined signal groups and a list of signals. Use this dialog box to add or remove signals from a group as described in the following steps.

1. Select **Debug** → **Settings** → **Signal Groups** or click the **Groups** button in the Debug Control Panel.
2. Click the down-arrow of the Groups drop-down list box and select the desired group.

The signals currently included in the selected group are listed in the Grouped Signals list box. The signals that are not included are displayed in the Available Signals list box.

3. Add or remove the signals you want using the < or > button.
4. Use the **Up** or **Down** buttons to rearrange the order of the signals.
5. Click **save** to save the new group.
6. Click **Close** to exit from the Signal Groups dialog box.

Note: To delete a group, go to the Signal Groups dialog box, select the existing group from the Groups drop-down list box, and click **Delete**.

Creating and Modifying a Signal List

The signal list can consist of signals, groups, and RAM bits. Use the Display Signals dialog box to create the list of signals to be displayed, including any signal groups that you have created.

Open the Display Signals dialog box and select the signals to include in the Displayed Signals list. The Displayed Signals list is a list of signals, groups, and RAM bits you select for probing with the Hardware Debugger.

Note: To display a new signal group, you must first define it in the Display Groups dialog box before adding it to the Displayed Signals list. Refer to the procedure in the “Creating a Signal Group” section.

1. Select **Debug** → **Settings** → **Display Signals** or click the **Display** button in the Debug Control Panel.

The Display Signals dialog box, shown in the following figure, appears.

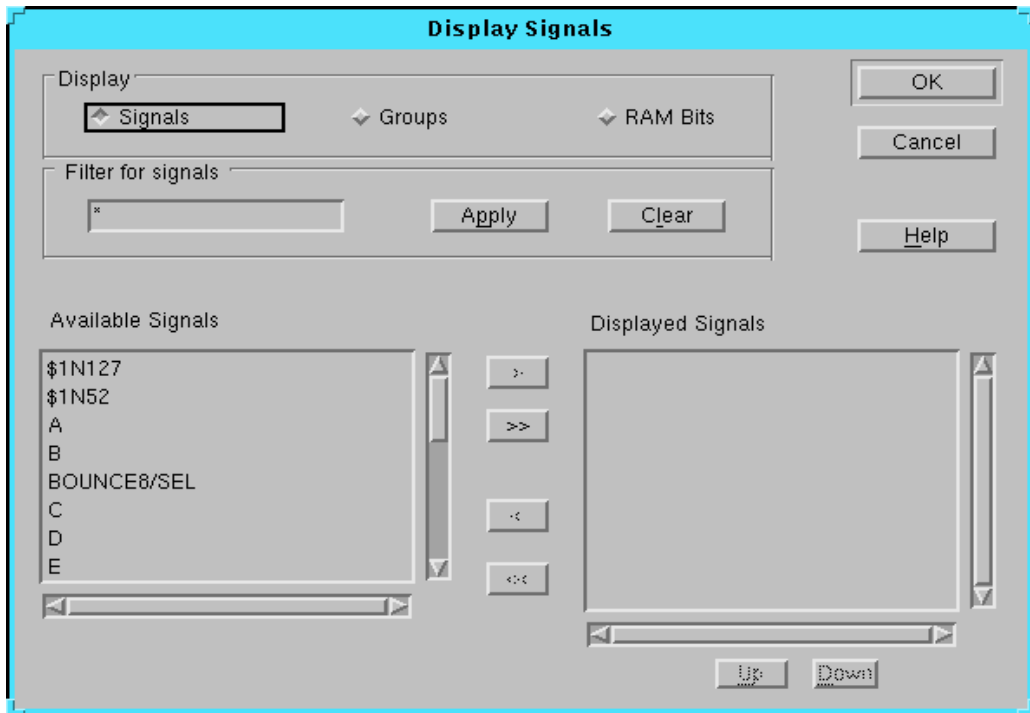

Figure 6-9 Display Signals Dialog Box

2. Click **Signals**, **Groups**, or **RAM Bits** to display the list of available signals, signal groups, or RAM bits.
3. Use the Filter for Signals field to make signal selection easier. For example, if you specify the letter “A” followed by a wildcard (*) all signal names that start with “A” are filtered
 Click **Apply** to apply the filter to the Signals displayed in the Available Signals list box. To redisplay the complete signal list, click **Clear**.
4. In the Available Signals list box, highlight one or more of the signals, groups, or RAM bits you want to probe.
5. Click the > button to move the highlighted signals to the Displayed Signals list box.

To remove signals from the Displayed Signals list box, select the signals and click the < button.

To add or remove all the signals displayed in a list box, use the << or >> button.

To rearrange the order of the signals displayed in the Displayed Signals list box, use the **Up** and **Down** buttons below the list box.

6. Click **OK** to exit from the Display Signals dialog box.

The current waveform is automatically updated with the new signals, which appear as cross-hatched hexagons.

Saving and Loading Readback Data

After generating a readback sequence of your signals, you can save the readback data you generated. Saving readback data is useful for multiple design analyses, for comparison, and design optimization.

You can view previously saved readback data textually or as waveforms. When the file is first opened, the data is displayed in a waveform. To view the data textually, use the View → Text Data command.

Saving Readback Data

Follow this procedure to save readback data.

1. Click on the waveform that you want to save and choose **File** → **save** or click the following toolbar button.



The Save As dialog box appears.

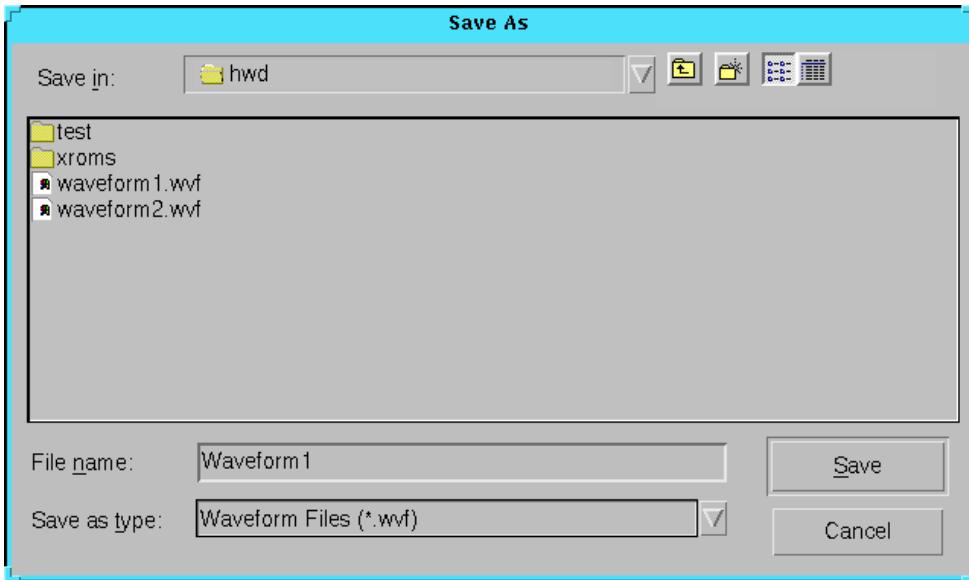

Figure 6-10 Save As Dialog Box

2. In the File Name field, type or select the name of the file you want to save. By default, the .wvf extension is appended to the file name.

If you want to change the path for your readback data, select the desired directory in the Directories field.

3. Click **OK** to save the data.

Viewing Previously Saved Readback Data

Follow these steps to view previously saved readback data.

1. Select **File** → **Open** → **Waveform** to view previously saved readback data.
2. In the Open dialog box, specify the file name and click **OK**.
The data is displayed in the format in which it was saved.
3. To view the data textually, select **View** → **Text Data** or click the following toolbar button.



4. To view the data graphically, select **View** → **Waveform Data** or click the following toolbar button.



Customizing the Interface

This chapter describes how to customize the Hardware Debugger. You can optimize its use by creating macros using predefined settings and changing the display parameters. This chapter describes these tasks in the following sections.

- “Using Macros”
- “Controlling the Waveform Display Parameters”

Using Macros

The Hardware Debugger allows you to define macros to automate tasks. After you have completed a procedure, you can capture the steps you want to include in your macro by selecting the commands from the Console window, copying them into a macro window, and saving the macro.

Alternatively, you can type the commands directly in a macro window. For information about the available commands and syntax, refer to the “Console Commands” appendix.

Creating a Macro

Follow these steps to create a macro.

1. Select **File** → **New** → **Macro**.

A macro window appears, as shown in the following figure.

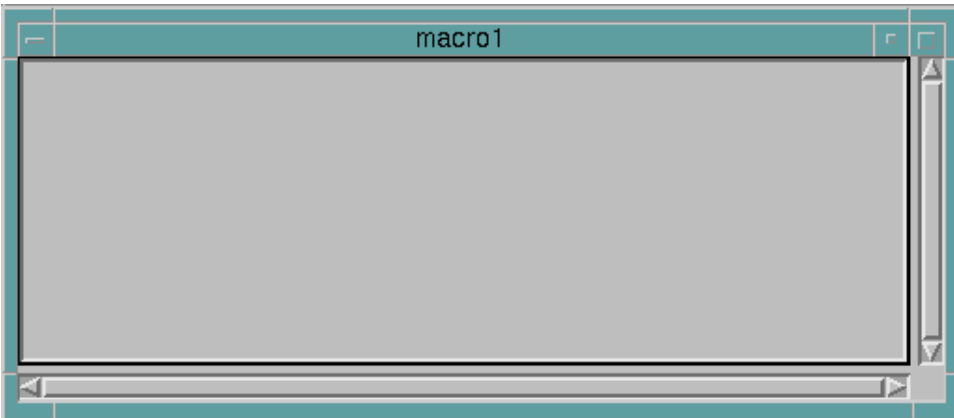

Figure 7-1 New Macro Window

2. Select **View** → **Console** to display the Console window and view the commands that have been executed.

The Console window appears.

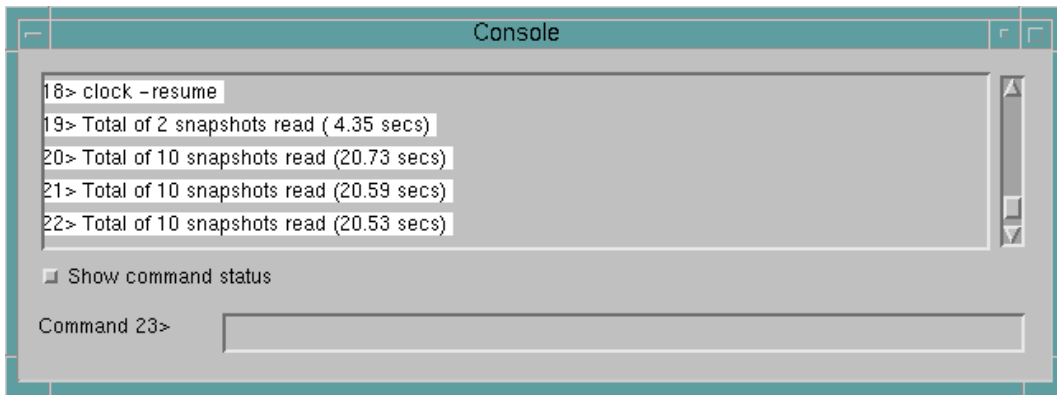

Figure 7-2 Console Window

3. Click the left mouse button at the beginning of the first command that you want to copy. Holding down the Shift key, click the left mouse button at the end of the last command you want to copy.
4. Copy the steps you want from the Console window by selecting **Edit** → **Copy**.

5. Select the macro window.
6. Paste the commands into the macro window by selecting **Edit** → **Paste**.
7. Repeat steps 3 through 6 to copy non-consecutive lines into the macro.
8. Use comments to note options and strategies, by preceding your comment text with the # character. Comments in a macro file always start with the # character on the line.
9. Save the macro using the **File** → **Save** or click the following toolbar button.



Editing an Existing Macro

To edit an existing macro, follow these steps.

1. Select **File** → **Open** → **Macro** from the menu and open the macro you want to modify from the list of macros in the Open Macro File dialog box.
2. In the Macro window, select commands by double-clicking the left mouse button to select a word. You can also select an entire block of text by pressing the left mouse button and dragging the mouse to the end of the region you want to copy.
3. Use the **Cut**, **Copy**, and **Paste** commands from the **Edit** menu to copy the selected information and paste it at the new insertion point.
4. Select **File** → **Save** to save the change or click the following toolbar button.



Running a Macro

To run a macro, follow these steps.

1. Open the macro by selecting **File** → **Open** → **Macro**.
2. Select **File** → **Run Macro** or click the following toolbar button.



Saving the Console Log to a File

You can check the command history for a debug session by opening the Console window. You can also save the command history, or command log, to a text file.

1. Select the contents of the Console window by clicking the left mouse button at the top of the window and dragging the cursor down to the end of the window.

To select the entire log, select the top part of the log, then click on the scroll bar to scroll down to the bottom of the page. At the bottom of the page, press the Shift key while you click the mouse button again to complete the selection.

2. Select **Edit** → **Copy** to copy the selected contents of the Console window to the clipboard.
3. Open a new file in a text editor and paste the contents of the clipboard into the file.

The contents of the Console window appear inside the file.

4. Save the file using the appropriate text editor command.

Controlling the Waveform Display Parameters

This section describes the features available for customizing your waveform window. After generating a waveform, you can modify its format by changing the display mode from graphics to text, modifying the radix of your groups, and changing the color of the waveform window background and signals. In addition, you can change

the size of the waveform and the position of the windows on the screen.

Waveform Window (Textual View)

In the text mode, the waveform window displays a textual representation of the device states you specified for viewing, as shown in the following figure. This view is a tabular display of the readback information.

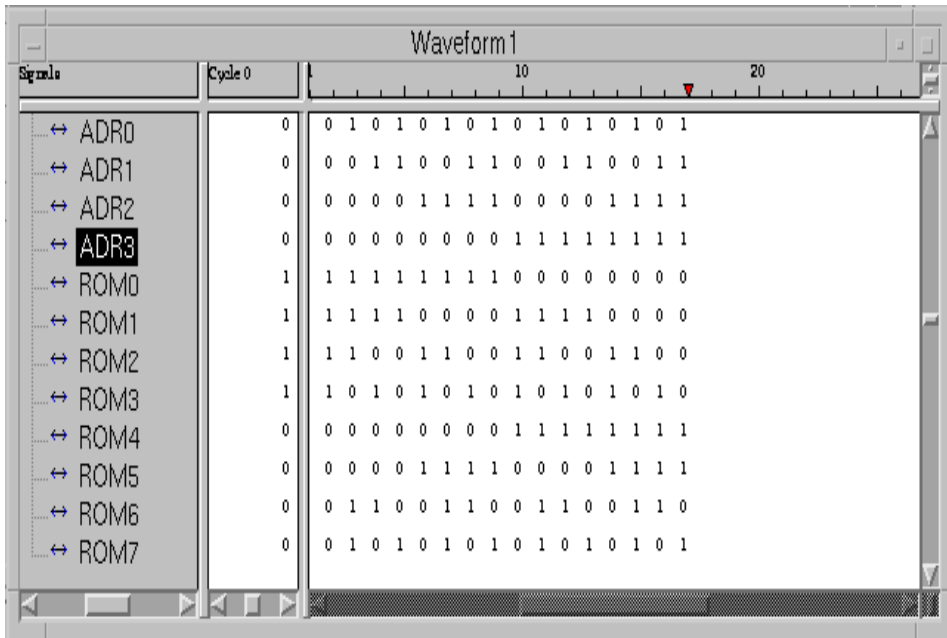

Figure 7-3 Active Waveform Window (Textual View)

The textual waveform window contains the following areas.

Signals

This column shows the names of the displayed signals and signal groups.

Cycle

The data in this column reflect the position of the vertical cursor in the text data window. The header shows the number of the selected snapshot. The column shows the readback values of the selected signals and signal groups.

Text Data Window

This column contains the following areas.

- Cycle Scale

This area, above the text data area, shows the snapshot counts, number of applied clock cycles, and reset states. Each snapshot count appears as a red triangle. The number of clock cycles applied between consecutive snapshots appears above each snapshot mark. Each Reset state appears as a blue diamond with a vertical line.

- Text Data

This display area shows text data for the readback values of signals and signal groups.

Waveform Window (Graphical View)

In the graphical mode, the waveform window displays a graphical representation of the signals you specified for viewing, as shown in the following figure.

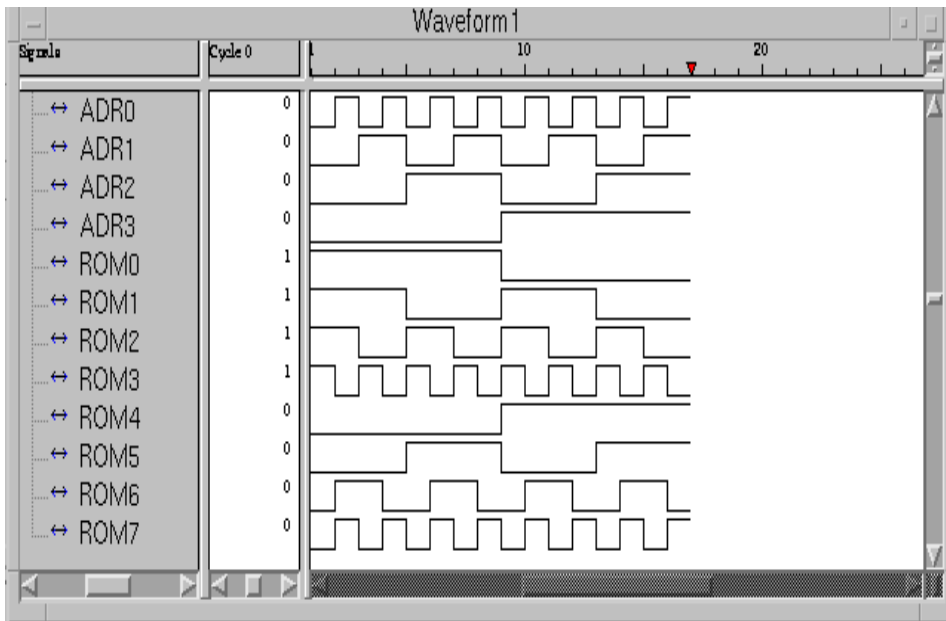

Figure 7-4 Active Waveform Window (Graphical View)

The Graphical Waveform window includes the following areas.

Signals

This column shows the names of the displayed signals and signal groups.

Cycle

The data in this column reflect the position of the vertical cursor in the waveform data window. The header shows the number of the selected snapshot. The column shows the readback value of the selected signals and signal groups.

Waveform Data Window

This column contains the following areas.

- Cycle Scale

This area, above the waveform data area, shows the snapshot counts, number of applied clock cycles, and reset states.

Each snapshot count appears as a red triangle. The number of clock cycles applied between consecutive snapshots appears above each snapshot mark.

Each Reset state appears as a blue diamond with a vertical line.

- **Waveform Data**

This display area shows waveforms for the readback values of signals and signal groups. Each signal appears as a semi-rectangular wave. Each signal group appears as a complete hexagonal wave.

Note: To start readback from the beginning, you can perform a waveform reset by using the Debug Reset Control. To clear, click right mouse.

Changing the Size of the Waveform

Use the options listed under the View menu to change the size of the waveform on your screen or to update your screen.

- Select **View** → **Zoom In** or click the Zoom In toolbar button to increase the size of your waveform.



- Select **View** → **Zoom Out** or click the Zoom Out toolbar button to decrease the size of your waveform.



- Select **View** → **Zoom To Fit** or click the Zoom To Fit toolbar button to fit all of the waveform cycles into the current window.



- Select **View** → **Zoom Reset** or click the Zoom Reset toolbar button to return the display to the default state.



- Select **View** → **Refresh** to redraw the elements on your screen and update the current waveform using the latest debugging modifications.

Controlling the Position of the Windows

To change the way the windows are displayed on your screen, follow these guidelines. The window that is in focus processes the commands you invoke.

- Select **Window** → **Arrange** to arrange the iconized windows as non-overlapping tiles at the bottom of the main window.
- Select **Window** → **Cascade** to display each window on top of the preceding window in a cascading arrangement.
- Select **Window** → **Tile Horizontally** to arrange the windows horizontally.
- Select **Window** → **Tile Vertically** to arrange the windows vertically.

Changing the Radix of Displayed Signal Groups

Use the **View** → **Group Radix** command to display or change the radices of your signal groups. Possible radices include binary, octal, decimal, and hexadecimal. The radix is applied to all groups.

1. Select **View** → **Group Radix** from the menu.
2. Click on the desired radix.

Changing the Color of the Waveform Window

You can change the color of the signals and background of the waveform window.

1. To modify a signal color, click on the signal in the waveform window that you want to modify.
2. Select **View** → **Color Signals**.
3. From the Color dialog box, select a color or create a custom color to select.
4. Click **OK** to apply the color change.
5. To modify the background color, click on the waveform window that you want to modify.
6. Select **View** → **Background Color**.
7. From the Color dialog box, select a color or create a custom color to select.
8. Click **OK** to apply the color change.

Removing a Signal

Use the popup menu commands in the Waveform window to remove signal waveforms.

1. Select the signal on the waveform.
2. Select **Delete Signals** from the popup menu.

Menu Commands

This chapter lists in alphabetical order the commands that are available from the Hardware Debugger menu bar. When applicable, the appropriate toolbar button is enclosed in the command description. This chapter contains the following sections.

- “Hardware Debugger Menus”
- “Alphabetical Listing of Commands”
- “Toolbar Buttons”

Hardware Debugger Menus

The Hardware Debugger has eight menus, which are described in the following sections.

File Menu

The File menu contains commands to load a configuration file, save readback data, use macros, print waveforms, and exit the program. The commands available from the File menu are the following.

New	Opens a new project, macro, or waveform
Open	Opens a project, macro, or waveform
Close	Closes the active window
Save	Saves the file
Save As	Saves the file with a new name
Run Macro	Executes the selected macro

Print Preview	Shows a print preview of the selected document
Print	Prints the selected document
1, 2, 3, 4	Displays up to four of the most recently opened documents
Exit	Exits the Hardware Debugger

Edit Menu

The Edit menu includes commands that allow you to edit the commands in the macro window. The commands available from the Edit menu are the following.

Undo	Allows you to undo the most recent edit command executed
Cut	Allows you to cut text
Copy	Allows you to copy text
Paste	Allows you to paste text
Delete	Allows you to delete text
Select All	Allows you to select all of the text in the flow

View Menu

The View menu includes commands to open the Console window, display special screen areas, and customize the waveform. The commands available from the View menu are the following.

Toolbar	Shows or hides the toolbar
Status Bar	Shows or hides the status bar
Console	Shows or hides the Console window
Control Panel	Shows or hides the Debug Control Panel
Text Font	Allows you to set the font, font style, and font size for text in a waveform window

Background Color	Allows you to set the waveform window background color
Text Data	Displays readback data textually rather than graphically
Waveform Data	Displays readback data graphically rather than textually
Color Signals	Allows you to set the color of the signals in the waveform window
Group Radix	Changes the waveform group radix to display binary, octal, decimal, or hexadecimal radix
Zoom In	Zooms in on selected waveform
Zoom Out	Zooms out on selected waveform
Zoom To Fit	Zooms waveform to fit the screen
Zoom Reset	Resets view to default values
Refresh	Refreshes views

Download Menu

The Download menu includes commands to download and verify a device configuration. The commands available from the Download menu are the following.

Note: These commands are available only when a project or waveform window is active.

Download Design	Programs the target device or devices with the configuration data
Download and Verify	Programs and verifies the configuration of a target device
Verify Bitstream	Verifies that a target device has been configured correctly
Readback and Capture	Performs readback on a device and stores the configuration and signal data into a file

Debug Menu

The Debug menu includes commands to specify the debugging mode and to debug. The commands available from the Debug menu are the following.

Note: These commands are available only when a project or waveform window is active.

Asynchronous Mode	Sets debug mode to asynchronous snapshot captures
Synchronous Mode	Sets debug mode to synchronous snapshot captures
Settings	Sets the options for the current debugging mode including the following: Trigger, Display Signals, Signal Groups, CLKO Clock Source, Number of Snapshots to Read, and Number of CLKO Clocks to Apply
Reset FPGA	Initializes the flip-flops of the target FPGA
Read Snapshot	Reads the state of the target device and displays the values for waveform signals selected for debugging
Apply CLKO Clock(s)	Applies the number of clocks you specified to the system clock
Start CLKO	Allows the system clock to run freely
Stop CLKO	Stops the system clock

Cable Menu

The Cable menu includes commands to set the cable communication between the Hardware Debugger and your target board. The commands available from the Cable menu are the following.

Communications	Specifies the cable options including the cable type, baud rate, and port name
Self Check	Performs a diagnostic of the XChecker Cable's internal components and data transmission capabilities
Logic Level of Pins	Displays the logic values of the cable pins
Reset	Resets the logic of the XChecker Cable
Configuration Mode	Displays the configuration modes supported through the MultiLINX Cable.

Window Menu

The Window menu includes commands to change the position of the Hardware Debugger windows on your screen. The commands available from the Window menu are the following.

Arrange	Arranges the iconized windows as non-overlapping tiles
Cascade	Positions the windows on top of one another in a cascading arrangement so that only the active window is fully shown, and only the title bars of the nonactive windows are visible
Tile Horizontally	Arranges the windows horizontally on the screen
Tile Vertically	Arranges the windows vertically on the screen
1, 2, 3, ...	Allows you to open the windows that were opened during a program session

Help Menu

The Help menu contains commands that enable you to access online help for the Hardware Debugger. The following are the Help menu commands and a brief explanation of each.

Help Topics	Displays help topics
Online Documentation	Starts online documentation tool
About Hardware Debugger	Displays the program information and copyright

Alphabetical Listing of Commands

The following commands are available in the menus of the Hardware Debugger's graphical user interface.

1, 2, 3, 4 (File Menu)

The File menu displays up to four of the most recently opened files, including projects, macros, or waveforms. To open a file, click on the file name in the menu.

1, 2, 3, ... (Window Menu)

The Window menu lists the names of all windows opened during a program session. These windows can be waveform, macro, or Console windows. To open a window, click on the window name in the menu.

About Hardware Debugger (Help Menu)

Select this command to display the version number of the Hardware Debugger and the copyright notice.

Apply CLK0 Clock(s) (Debug Menu)

Select this command to apply a specified number of clock cycles to the CLK0 pin on the XChecker Cable during synchronous debugging. Each time you select this command, the number of clocks you specified with the Debug → Settings → Number of CLK0 Clocks to

Apply command is applied. This option is available only after you have defined the clock settings.

You can also use the Apply button in the Clock Control group box of the Debug Control Panel to run this command.

Arrange (Window Menu)

Select this command to arrange the windows icons as non-overlapping tiles at the bottom of the Hardware Debugger main window.

Asynchronous Mode (Debug Menu)

Select this command to set the debug mode to asynchronous debugging. In asynchronous mode, neither the Hardware Debugger nor the XChecker Cable controls the clock for the target FPGA. Debugging is performed asynchronously with respect to the clock.

Debugging is available only if the cable selected is an XChecker Cable and if the current file is a BIT file. Make sure you prepare your design for debugging as specified in the “Design Preparation” chapter. Make sure you configure the XChecker Cable as specified for asynchronous mode in the “Connecting Your Cable” chapter.

After you select the asynchronous debug mode, the Settings submenu commands and the options in the Debug Control Panel are activated for the appropriate mode.

You can also click the following toolbar button to run this command.



Background Color (View Menu)

Use this command to modify the background color of the current waveform window. This command displays the Color dialog box. Select the appropriate color in the Color dialog box and click **OK** to apply the change to the waveform window.

Cascade (Window Menu)

Select this command to display each new window on top of the preceding window in a cascading arrangement. The active window processes the commands you invoke.

Close (File Menu)

Use this command to close the selected project, macro, or waveform. This command is active only if there is an active window. If the active window has been modified, a confirmation dialog box appears, prompting you to save the changes.

You can also click the following toolbar button to run this command.



Color Signals (View Menu)

Use this command to modify the color of the current waveform signals. This command displays the Color dialog box. Select the appropriate color in the Color dialog box and click **OK** to apply the change to the waveform.

Configuration Mode (Cable Menu)

Select this command to display the Configuration Mode dialog box, as shown in the following figure.

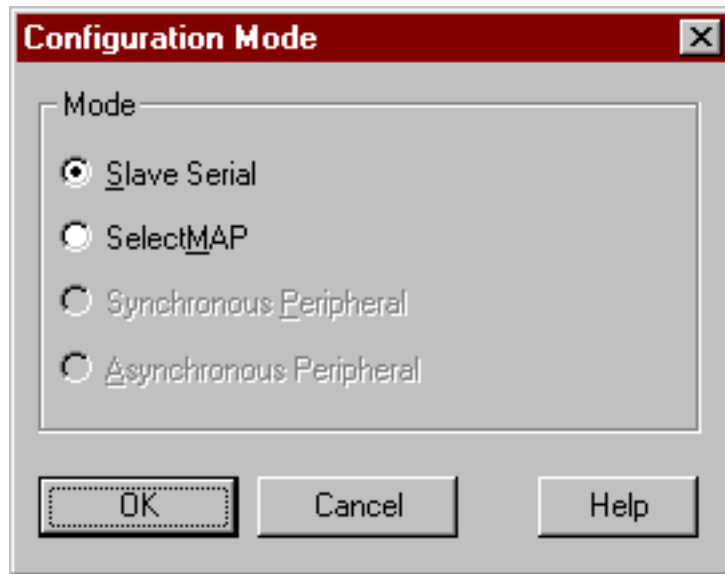

Figure 8-1 Configuration Mode Dialog Box

The Configuration Mode dialog box Cable includes the following options only when using the MultiLINX Cable.

- Slave Serial

The **Slave Serial** configuration mode is supported through the MultiLINX Cable.

- SelectMAP

The **SelectMAP** configuration mode can only be used with Virtex family devices through the MultiLINX Cable.

- Synchronous Peripheral
- Asynchronous Peripheral

Note: The Synchronous Peripheral and Asynchronous Peripheral mode options will remain grayed out since they are currently not supported.

Communications (Cable Menu)

Select this command to display the Communications Setup dialog box, as shown in the following figure. You can set the following cable options for downloading and debugging: cable type, baud rate, and port. Once defined, these settings are saved for the next program session.

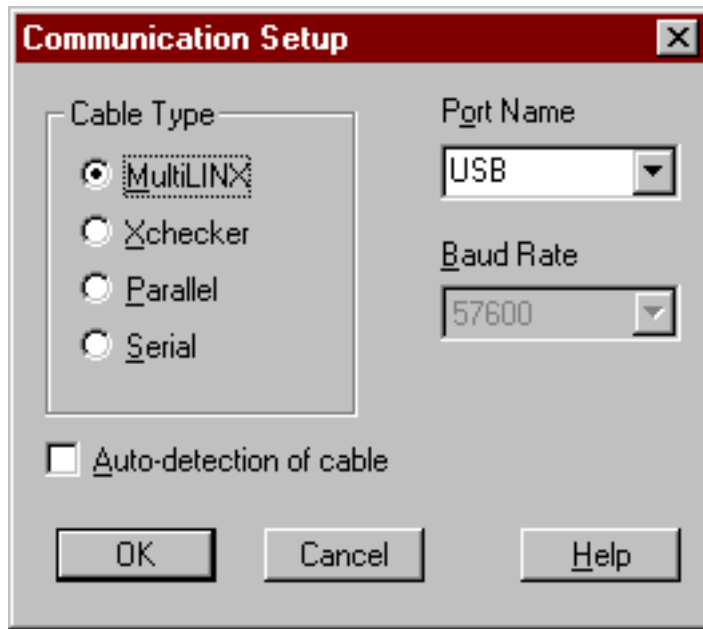

Figure 8-2 Communication Setup Dialog Box

Note: There is no baud rate control for USB port. The maximum baud rate through USB is 12M bits/sec.

Communication Setup Dialog Box

The Communication Setup dialog box includes the following options.

- Cable Type

Select either **MultiLINX**, **XChecker**, **Parallel**, or **Serial** cable. The MultiLINX Cable allows you to download and verify through USB and RS-232 serial ports. The XChecker Cable allows

you to download, verify, and debug through the RS-232 serial port. The parallel and serial cables allow you to download only.

Note: The parallel cable is supported on the PC only.

- Port Name

Select the port to be used for downloading and readback from the Port Name drop-down list box. This box contains a list of valid ports. If the port name you want is not listed, select the blank name from the list box and type in the new port name. This list box saves up to two user-specified port names.

- Baud Rate

Select a communications baud rate between the selected cable and the host system from the Baud Rate drop-down list box.

- Auto-detection of Cable

Select this option to enable the software to scan through all of the ports to find if there is a cable connected. If a cable is connected, the status bar lists this information.

- OK

Click **OK** to exit this dialog box and set the specified options.

- Cancel

Click **Cancel** to exit the current dialog box without changing any settings.

Console (View Menu)

Use this command to show or hide the Console window. By default, the Console window is closed. The Console window, consists of a display and an option used to specify the status mode. Use the Console window to view the command history. You can also run commands from the Console window command bar.

To exit the Console window, select **View** → **Console**.

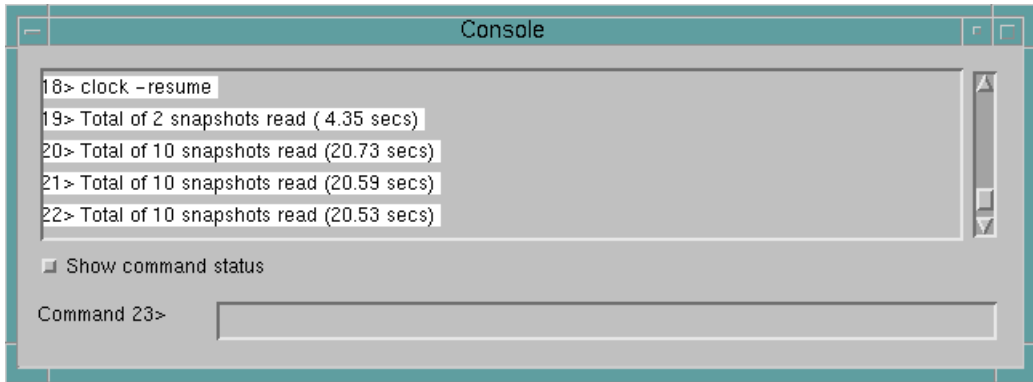

Figure 8-3 Console Window

Console Window Options

The Console window includes the following areas and options.

- **Display Area**

The Console window is for read access only; you cannot edit the commands in the display. However, you can copy the commands and paste them in a macro window.

Click on a command with the left mouse button to select the entire command line. Use the Shift key to select multiple consecutive lines when used with the mouse.

- **Show Command Status**

Select this option to display the commands in the window, along with the status information that was provided at the time the commands were executed.

Deselect this option to display the commands only.

- **Command Bar**

The command bar is located at the bottom of the Console window. You can enter Hardware Debugger commands using the appropriate syntax and correct sequence. You will be notified by a message if you enter commands in the wrong order. Refer to the

“Console Commands” appendix for command syntax information.

Console Window Popup Menu Commands

Click the right mouse button while positioned over the Console window to bring up a popup command menu. You can access the following commands from within the Console window.

- **Copy Commands**
Use this command to copy Hardware Debugger commands.
- **Run Commands**
Use this command to run the Hardware Debugger commands.

Control Panel (View Menu)

Select this command to show or hide the Debug Control Panel. The Control Panel allows you to run various debugging commands. In synchronous mode, the clocking features are enabled on the Control Panel. In asynchronous mode, they are disabled.

To use the Debug Control Panel you must load a BIT file configured for device verification and debugging as described in the “Design Preparation” chapter.

Note: This menu item will be disabled for MultiLINX and will appear grayed out.

Debug Control Panel for Synchronous Mode

In synchronous mode, the Debug Control Panel displays the debugging options listed in the following tables. Each option is also available as a menu option from the Debug menu.

To set up the readback options, use the buttons in the Setup group box of the Debug Control Panel. See the following table for a list of each option.

Table 8-1 Setup Options (Synchronous Mode)

Control Panel Button	Setup Group Box Function
Clocks	Displays the CLK0 Clock Settings dialog box in which you can specify the type and frequency of the clock Equivalent to Debug → Settings → CLK0 Clock Source
Triggers	Displays the Synchronous Trigger Settings dialog box in which you can select the type of trigger that initiates a snapshot capture and the number of clock cycles before and between snapshots Equivalent to Debug → Settings → Trigger
Groups	Displays the Signal Groups dialog box in which you can define signal groups for debugging and waveform displays Equivalent to Debug → Settings → Signal Groups
Display	Displays the Display Signals dialog box in which you can specify signals, signal groups, and RAM bits to include in the display list for debugging Equivalent to Debug → Settings → Display Signals

To read back a device, use the buttons in the Readback Control group box of the Debug Control Panel. See the “Readback Control Options (Synchronous Mode)” table for a list of each option.

Table 8-2 Readback Control Options (Synchronous Mode)

Control Panel Button	Readback Control Group Box Function
Number of Snapshots	Allows you to enter the number of snapshots to read and display in the debugging window Equivalent to Debug → Settings → Number of Snapshots to Read

Table 8-2 Readback Control Options (Synchronous Mode)

Read	Reads back the target device and captures snapshots for the states of the signals selected for debugging Equivalent to Debug → Read Snapshots
Pulse /RESET	Initializes the flip-flops in the target device that are connected to the RESET pin of the XChecker Cable; generates an active-Low pulse Equivalent to Debug → Reset FPGA

To control the clock, use the buttons in the Clock Control group box of the Debug Control Panel. See the “Clock Control Options (Synchronous Mode)” table for a list of each option.

Table 8-3 Clock Control Options (Synchronous Mode)

Control Panel Button	Clock Control Group Box Function
Number of Clocks	Allows you to enter the number of clock cycles to apply to your device Equivalent to Debug → Settings → Number of CLKO Clocks to Apply
Apply	Applies the clock cycles specified in the Number of Clock field to the XChecker CLKO pin Equivalent to Debug → Apply CLKO Clocks
Start	Allows the CLKO pin on the XChecker Cable to oscillate freely Equivalent to Debug → Start CLKO
Stop	Interrupts the system clock being applied to the target device Equivalent to Debug → Stop CLKO

Debug Control Panel for Asynchronous Mode

In the asynchronous mode, the Debug Control Panel displays the debugging options listed in the following tables. Each button is also available as a menu option from the Debug menu.

To set up the readback options, use the buttons in the Setup group box of the Debug Control Panel. See the “Setup Options (Asynchronous Mode)” table for a list of each option.

Table 8-4 Setup Options (Asynchronous Mode)

Control Panel Button	Readback Setup Group Box Function
Triggers	Displays the Asynchronous Trigger Settings dialog box in which you can select the type of trigger that initiates a snapshot capture Equivalent to Debug → Settings → Trigger
Groups	Displays the Signal Groups dialog box in which you can define signal groups for debugging and waveform display Equivalent to Debug → Settings → Signal Groups
Display	Invokes the Display Signals dialog box in which you can specify signals, signal groups, and RAM bits to include in the display list for debugging Equivalent to Debug → Settings → Display Signals

To read back a device, use the buttons in the Readback Control group box of the Debug Control Panel. See the “Readback Control Options (Asynchronous Mode)” table for a list of each option.

Table 8-5 Readback Control Options (Asynchronous Mode)

Control Panel Button	Readback Control Group Box Function
Number of Snapshots	Allows you to enter the number of snapshots to read and display in the debugging window Equivalent to Debug → Settings → Number of Snapshots to Read

Table 8-5 Readback Control Options (Asynchronous Mode)

Read	Reads back the target device and captures snapshots for the states of the signals selected for debugging Equivalent to Debug → Read Snapshots
Pulse /RESET	Initializes the flip-flops in the target device that are connected to the RESET pin of the XChecker Cable; generates an active-Low pulse Equivalent to Debug → Reset FPGA

Copy (Edit Menu)

Select this command to copy highlighted text from the macro or Console window. You can paste this text to a different window using the Paste command.

Cut (Edit Menu)

Select this command to cut highlighted text from the macro window. You can paste this text to a different window using the Paste command.

Delete (Edit Menu)

Select this command to delete command text from the macro window.

Download and Verify (Download Menu)

Select this command to download a configuration bitstream and verify it immediately after downloading. The output of the verification is displayed in a dialog box. This command is active only if you are using a MultiLINX Cable or an XChecker Cable and if the current file is a BIT file configured for readback. See the “Downloading and Verifying a Design” section of the “Programming a Device or a Daisy Chain” chapter for information on how to use this command.

You can also click the following toolbar button to run this command.



Download Design (Download Menu)

Select this command to download the current configuration data to a device or device chain. When you download a design, you program a device or daisy chain of devices, with the functions described by that design. See the “Downloading to a Target Board” section of the “Programming a Device or a Daisy Chain” chapter for information on how to use this command.

This command is active only if you have opened a project.

You can also click the following toolbar button to run this command.

If using a MultiLINX Cable, for PROM files and Virtex family bit files, a “Configuration Mode” dialog box will pop up. Select the configuration mode in which to program the target FPGA. If you are in SelectMAP mode, the following Set Chip Select dialog box will pop up asking which Chip Select line to use.

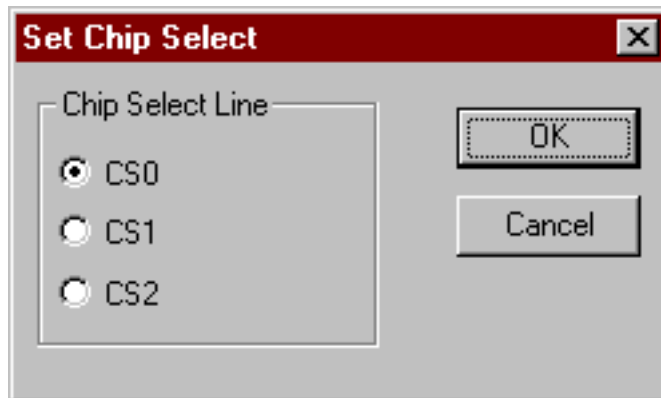

Figure 8-4 Shapeliest Dialog Box

If you are in Slave Serial mode (MultiLINX Cable default mode) set the CS0 on the Chip Select line.



Exit (File Menu)

Select this command to end the current Hardware Debugger session. If you have not saved your data, you are prompted to save before exiting.

Group Radix (View Menu)

Select this command to change the base or radix used by the signals groups in the waveform display. There are four possible radices: binary, octal, decimal, and hexadecimal. Select the radix you want to use for your signal groups. The radix is applied to all groups.

Help Topics (Help Menu)

Select this command to display the opening screen of Hardware Debugger help. From the opening screen, you can jump to step-by-step instructions for using the Hardware Debugger and to various types of reference information.

After you open help, you can click the Help Topics button in the Help window to return to the opening screen of Help.

For more information about online help, see the “Using Help” section of the “Getting Started” chapter.

Logic Level of Pins (Cable Menu)

Warning: Do not connect the XChecker or MultiLINX TTL leads to signals of different voltage levels than required because you might damage the XChecker internal hardware. Do not connect the control signals to XChecker before VCC and ground. The input/output pins of their internal FPGA should always be at a lower or equal potential than the rail voltage to avoid internal damage.

Select this command to display the logic levels of the cable pins and to probe static logic values on your board. This information is

displayed in the Cable Logic Level dialog box, as shown in the following figure. This command is only available when using the XChecker and MultiLINX cables.

Note: In logic scan mode, the pins function as probes scanning for TTL level logic, not as configurations or boundary scan pins.



Figure 8-5 Cable Logic Level Dialog Box

Cable Logic Level Dialog Box

The Cable Logic Level dialog box includes the following options.

- **Scan Status Constantly**
Select this option to enable the software to continually scan and update the status of the cable pins.
- **Configuration and Probe Pins**
The logic level of the following pins are provided for the XChecker and MultiLINX cables: RESET, INIT, PROG, D/P, CCLK, TRIG, DIN, RD, RT, TCK, TMS, and TDI.

Check the logic levels of your header pins before programming or reading back a device. Before downloading a file, the value of the D/P pin should be 0; after downloading the design, the value of the D/P pin should be 1.

- Close

Click **C**lose to save the settings and exit the dialog box.

New (File Menu)

Select this command to open a new macro or waveform. The New command brings up a submenu with the following commands.

- Macro
- Project
- Waveform

New → Macro (File Menu)

A macro is a sequence of commands that you can run like a batch file.

Unlike the Console window, a macro window includes an editable text area in which you can type the commands you want to use in the macro, as shown in the “New Macro Window” figure.

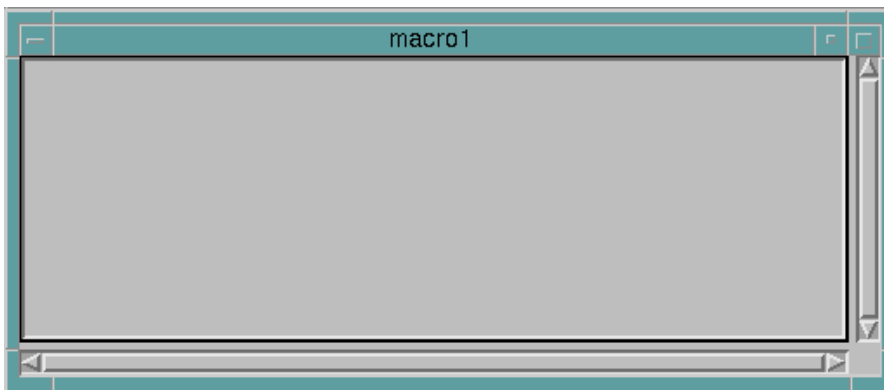

Figure 8-6 New Macro Window

The macro window contains a display area. You can select commands using the mouse by double-clicking the left mouse button to select a word. You can also select an entire block of text by pressing the right mouse button and dragging the mouse to the end of the region you want to copy.

Macro Window Popup Menu Commands

Click the right mouse button while positioned over the macro window to bring up a popup command menu. You can access all of the commands from the Edit menu in this popup menu. See the “Edit Menu” section for more information.

New → Project (File Menu)

Select this command to open the New Project dialog box, shown in the “New Project Dialog Box” figure. Use this dialog box to choose a bitstream file to open. Select this command to open a BIT file (.bit extension), which is a binary representation of your design, or a PROM file (.mcs, .tek, or .exo extensions). You can also open a Rawbits file, called an RBT file (.rbt extension), which is the ASCII version of the BIT file. You must open the bitstream before downloading or debugging your design.

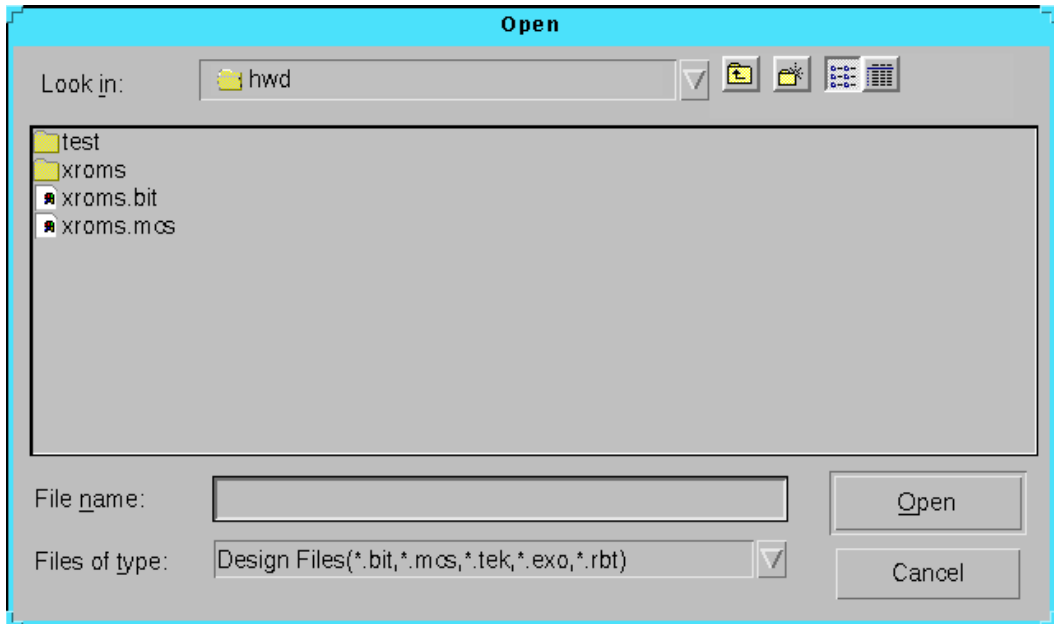

Figure 8-7 New Project Dialog Box

If you open a BIT file, you can download and debug your design. To verify, read back, and debug a BIT file, you must have a logic allocation file (*design_name.ll*) in the design directory. If you open a PROM file, you can program several FPGA devices at once. You cannot use PROM or RBT files for verification and debugging.

After you choose a file to open, a project window appears that shows the hierarchical structure of files for each project. Each project contains bitstream, macro, and waveform data. The device name is only included in this hierarchy when you open a BIT file.

You can also use the following toolbar button to run this command.



New Project Dialog Box

The New Project dialog box includes the following options.

- Look In

Use this field to specify a directory.

- File Name

This area uses the file extension you selected in the List Files of Type field to filter the files in the current directory. Only the files that match the specified extension are displayed in the File Name list box. You can use wildcards (*) and letters in this field to sort out various files.

To select a file, click on the file name in the File Name list box. Alternatively, you can type the file name and extension of the desired file in the File Name field.

- Files of Type

Use this field to specify which file extension to use to filter the files in the File Name area. Select an extension or group of extensions from the drop-down list box.

- Open

Click **Open** to exit the dialog box and open the selected design.

- Cancel

Click **Cancel** to exit the current dialog box without creating a project.

New → Waveform (File Menu)

Select this command to open a new graphical waveform window. If you select this option, the next time you use Debug → Read Snapshots, the readback signal values are displayed in the new waveform instead of the existing waveform.

Open (File Menu)

Select this command to open an existing project, macro, or waveform. The Open command displays a submenu with the following commands.

- Macro
- Project
- Waveform

Open → Macro (File Menu)

Select this command to open the Open Macro dialog box, shown in the following figure. Use this dialog box to specify a macro to open. Macros run Hardware Debugger commands, which can range from a single step, such as setting the baud rate, to a complete downloading and debugging session.

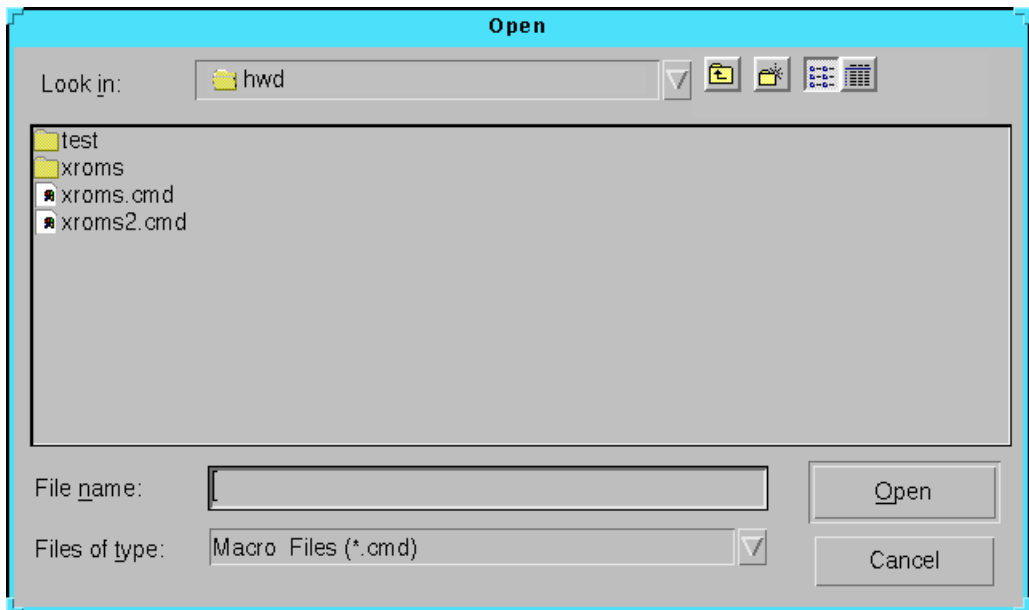

Figure 8-8 Open Macro Dialog Box

Open Macro File Dialog Box

The Open Macro dialog box includes the following options.

- Look In
Use this field to specify a directory.

- File Name

This field displays the .cmd file extension selected in the List Files of Type box. Only the files that match the specified extension are displayed in the list box. You can use wildcards (*) and letters in this field to sort out various files.

To select a file, click on the file name in the File Name list box. Alternatively, you can type the file name and extension of the desired file in the File Name field.

- Files of Type

This box displays the file extension .cmd, that is used to filter the files in the File Name area.

- Open

Click **Open** to exit the dialog box and open the selected macro.

- Cancel

Click **Cancel** to exit the current dialog box without opening a macro.

Macro Window Popup Menu Commands

After you select options in the Open Macro dialog box, a macro window appears. Click the right mouse button while positioned over the macro window to bring up a popup command menu. You can access all of the commands from the Edit menu in this popup menu. See the “Edit Menu” section for more information.

Print (File Menu)

Select this command to print the data from the selected waveform window. This command displays the Print dialog box, which allows you to specify printer options.

Print Dialog Box

Print dialog boxes vary between workstations and PCs. The options can include the following.

- Print Range
 - All

Select **A11** to print the entire file.

- Pages From

Enter the beginning of the range of pages to print.

- Pages To

Enter the end of the range of pages to print.

- Copies

Enter the number of copies you want to print.

- Setup

Select **Setup** to display the printer Manager dialog box.

- Print to File

Select this box to print to a file.

- OK

Click **OK** to exit the dialog box and print the window.

- Cancel

Click **Cancel** to exit the dialog box without printing the window.

Open → Project (File Menu)

Select this command to display the Open Project dialog box from which you can choose a project file (.xck file extension). The XCK file contains design dependent information, such as design file name, waveform and macro name, and dialog box settings. The design file can be a BIT file, or a PROM file (.mcs, .tek, or .exo). It can also be an RBT file (.rbt) which is the ASCII version of the BIT file. You must open the bitstream file before downloading or debugging your design.

After you choose a file to open, a project window appears that shows the hierarchical structure of files for each project. Each project contains bitstream, macro, and waveform data. You can use the popup menu commands within this window.

Note: The part number appears in the project hierarchy only when you have chosen a BIT file to open.

Use the Open Project dialog box, to specify which project to open.

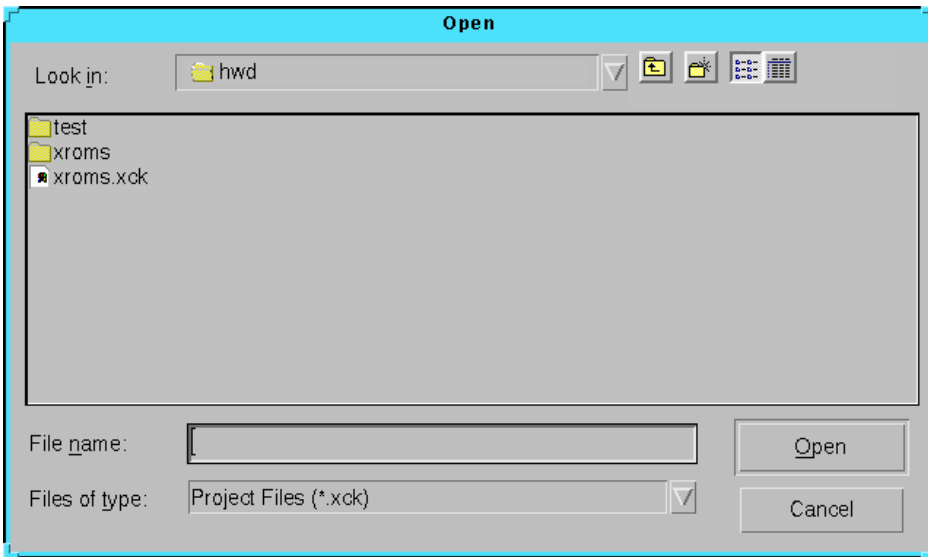

Figure 8-9 Open Project Dialog Box

You can also use the following toolbar button to run this command.



Open Project Dialog Box

The Open Project dialog box includes the following options.

- **Look In**
Use this field to specify a directory.
- **File Name**
This area uses the .xck extension to filter the files in the current directory. Only the files that match the specified extension are displayed in the File Name list box. You can use wildcards (*) and letters to sort out various files.

To select a file, click on the file name in the File Name list box. Alternatively, you can type the file name and extension of the desired file in the File Name field.

- Files of Type

This field displays the file extension .xck that is used to filter the files in the File Name area.

- Open

Click **Open** to exit the dialog box and open the selected project.

- Cancel

Click **Cancel** to exit the current dialog box without opening a project.

Project Window Popup Menu Commands

Click the right mouse button while positioned over the project window to bring up a popup list of commands. Each command is run on the selected project. The following commands are available.

- New

This command creates a new macro or waveform.

- Open

This command opens the selected project, macro, or waveform.

- Delete

This command deletes the selected file.

Note: This command is not available as a menu command.

- Run

This command runs the commands of the selected macro.

- Download

This command is equivalent to the Download → Download Design command. See the “Download Design (Download Menu)” section.

- Download and Verify

This command is equivalent to the Download → Download and Verify command. See the “Download and Verify (Download Menu)” section.

- Verify Bitstream

This command is equivalent to the Download → Verify Bitstream command. See the “Verify Bitstream (Download Menu)” section.

- Readback and Capture

This command is equivalent to the Download → Readback and Capture command. See the “Readback and Capture (Download Menu)” section.

Open → Waveform (File Menu)

Select this command to view previously saved waveform data. When the file is first opened, the data is displayed graphically. To view the data textually, use the View → Text Data command.

Use the Open Waveform dialog box, displayed in the following figure, to specify which waveform file to open.

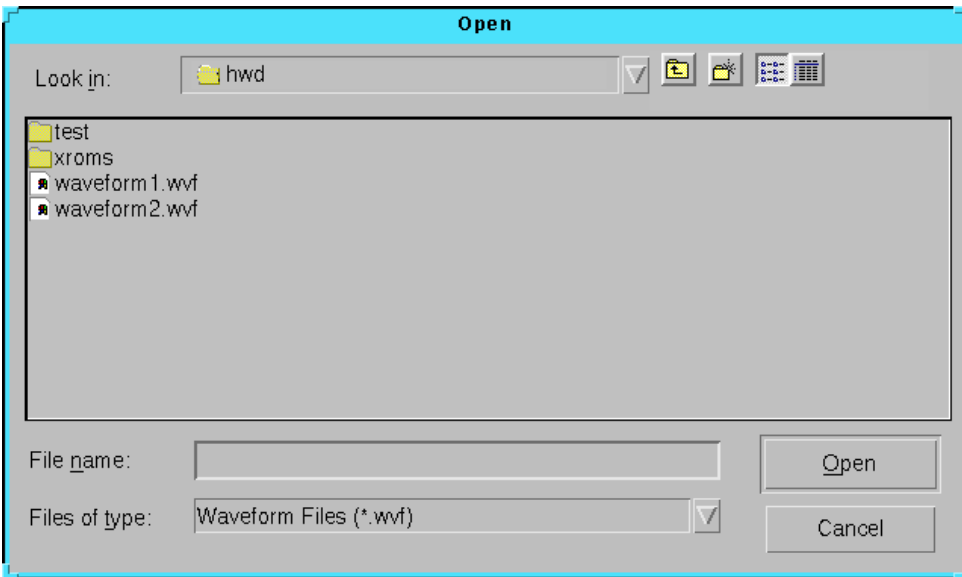

Figure 8-10 Open Waveform Dialog Box

To open the file, specify the file name and click **Open**. A waveform is displayed as a waveform window within the Hardware Debugger main window.

Open Waveform Dialog Box

The Open Waveform dialog box includes the following options.

- Look In

Use this field to specify a directory.

- File Name

This field displays the .wvf file extension currently selected in the List Files of Type field. Only the files that match the specified extension are displayed in the list box. You can use wildcards (*) and letters in this field to sort out various files.

To select a file, click on the file name in the File Name list box. Alternatively, you can type the file name and extension of the desired file in the File Name field.

- Files of Type

This box displays the file extension .wvf that is used to filter the files in the File Name area.

- Open

Click **Open** to exit the dialog box and open the selected waveform.

- Cancel

Click **Cancel** to exit the dialog box without opening a waveform.

Waveform Window Popup Menu Commands

After you make settings in the Open Waveform dialog box, a waveform window appears. Click the right mouse button while positioned over the waveform window to bring up a popup command menu. You can access the following commands from within the waveform window.

- Clear All Waveforms

Select this command to clear the all waveforms from the waveform window.

- Delete Signals

Click on the signal you want to delete and select this command to remove a signal from a waveform.

- Color Signals

Click on the signal that you want to modify and select this command. Modify the signal color by selecting the appropriate color in the Color dialog box.

Paste (Edit Menu)

Select this command to paste cut or copied text to the macro window.

Print (File Menu)

Select this command to print the data from the selected waveform window. This command displays the Print dialog box, which allows you to specify printer options.

Print Dialog Box

Print dialog boxes vary between workstations and PCs. Six basic options in this dialog box follow.

- Print Range

- All

Select **A11** to print the entire file

- Pages From

Enter the beginning of the range of pages to print.

- Pages To

Enter the end of the range of pages to print.

- Copies

Enter the number of copies you want to print.

- Setup

Select **Setup** to display the printer Manager dialog box.

- Print to File

Select this box to print to a file.

- OK

Click **OK** to exit the dialog box and print the window.

- Cancel

Click **Cancel** to exit the dialog box without printing the window.

Print Preview (File Menu)

Select this command to preview the waveform window to be printed. This command brings up a waveform image based upon the font and size selections you make with the View → Text Font command.

Read Snapshots (Debug Menu)

Select this command to read back the signals that you selected for viewing. The software generates a readback of all the configuration data, extracts the signals you selected for viewing, and displays the signal values in the current waveform. The software takes the number of snapshots specified in the Debug → Settings → Number of Snapshots to Read command.

You can also click the Read button in the Readback Control group box of the Debug Control Panel to run this command.

Note: The readback data stream is linked to the active waveform window only. After you close the connection, the waveform window is not updated with new information.

Readback and Capture (Download Menu)

Select this command to perform readback on a device and store the data into a binary file. The data consists of configuration and signal data.

You can also click the following toolbar button to run this command.



Refresh (View Menu)

Select this command to refresh and update the waveform display.

Reset (Cable Menu)

Select this command to reset the internal logic of the cable. Verify that the cable is reinitialized and the baud rate is set prior to using the reset command.

After a power glitch, you should first reset the cable to reconfigure the XChecker internal FPGA device and then reconfigure the target device.

Reset FPGA (Debug Menu)

Select this command to initialize the target FPGA internal flip-flops that are connected to the XChecker RESET pin. This option generates an active-Low pulse. If you have not set the Pulse RESET at First Snapshot option in the Trigger Settings dialog box, you can use this command to reset the target device's internal flip-flops.

You can also click the Pulse /RESET button in the Readback Control group box of the Debug Control Panel to run this command.

Note: If you do not open a new waveform window when you use this command, the reset point appears in the current waveform window. Each Reset state appears as a blue diamond with a vertical line.

Run Macro (File Menu)

Select this command to run the commands in the selected macro window. If a macro window is not selected, a dialog box appears, prompting you for a macro file name.

You can also click the following toolbar button to run this command.



Save (File Menu)

Use the Save command to save an existing project, macro, or waveform. The file in the active window is saved.

You can also click the following toolbar button to run this command.



Save As (File Menu)

Use the Save As command to save an existing project, macro, or waveform with a new name. The file in the active window is saved. The Save As dialog box is displayed, allowing you to specify the name under which to save the file.

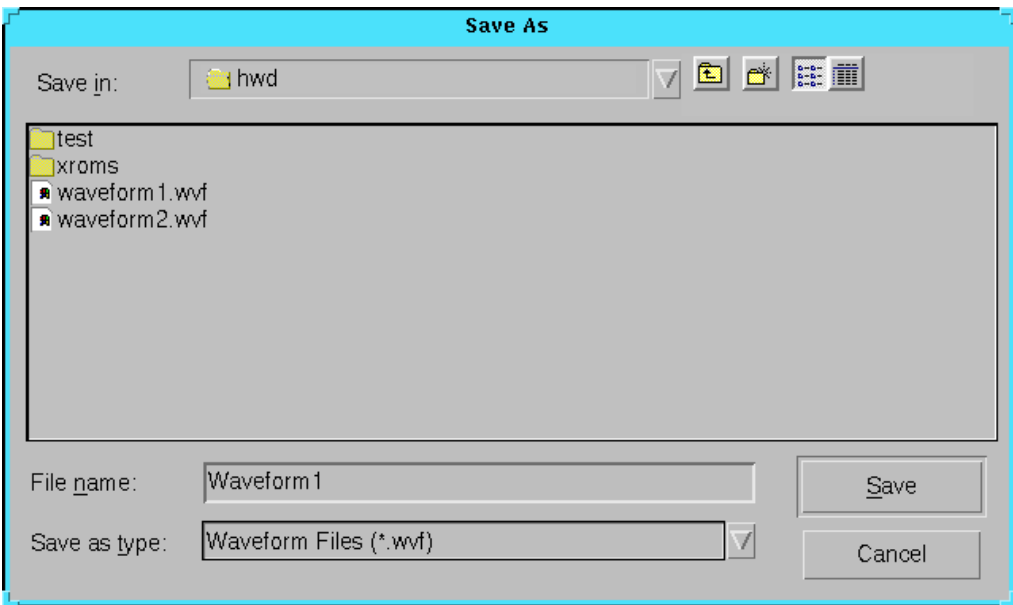

Figure 8-11 Save As Dialog Box

Save As Dialog Box

The Save As dialog box includes the following options.

- **Save In**
Use this field to specify a directory.
- **File Name**
This field displays the file extension selected in the List Files of Type field. The File Name list box displays existing files that have the specified extension.
Type a file name in the File Name box. The file extension is automatically appended when you click Save.
- **Save as Type**
This field displays the appropriate file extension for the file currently displayed.
- **Save**

Click **Save** to exit the dialog box and save the data.

- **Cancel**

Click **Cancel** to exit the current dialog box without saving the data.

Select All (Edit Menu)

Select this command to select all of the text in the macro window. You can then copy this text to a different window.

Self Check (Cable Menu)

Select this command to perform a diagnostic of the MultiLINX Cable and the XChecker Cable hardware. The tests ensure that data can be transmitted and received at the different baud rates and that the internal FPGA and RAM are operational. See the “Testing the XChecker Cable” section of the “Connecting Your Cable” chapter for information on how to set up the hardware for testing.

Cable Self Check for the MultiLINX Cable

Make settings in the Cable Self Check dialog box, as shown in the following figure, to specify which tests you want to perform and how these tests are conducted.

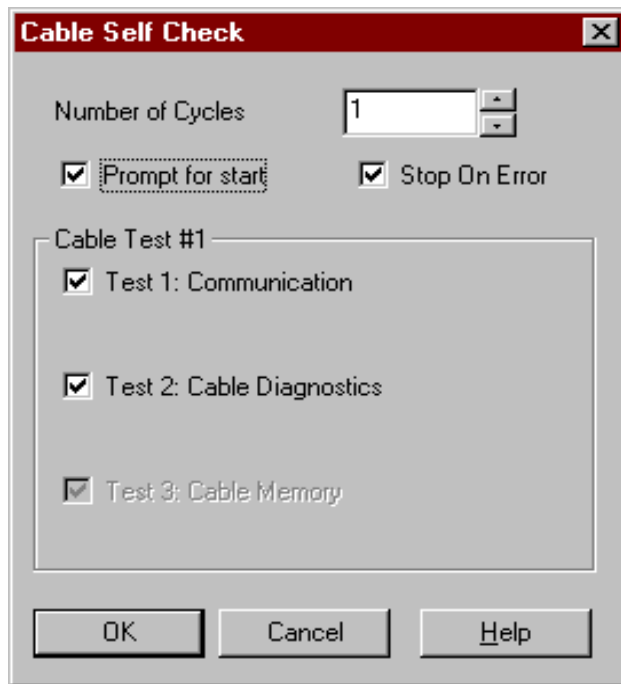

Figure 8-12 Cable Self Check Dialog Box (MultiLINX Cable)

Cable Self Check Dialog Box

The Self Check dialog box includes the following options.

- **Number of Cycles**
Specify the number of test cycles that you want to run.
- **Prompt for Start**
Select this option to display a dialog box that allows you to manually start each test. Click **OK** in this dialog box to begin testing.
- **Stop on Error**

Select this option to stop testing when the software encounters an error. When testing stops due to an error, the status window displays the type of error encountered.

- **Cable Test #1**

Select the type or types of tests you want to run on your MultiLINX Cable hardware. The diagnostics routines consist of software loops that verify the functions of the cable. The following tests are run.

- **Test 1: Communication**

This test checks the cable communication with the port on the host system at the selected baud rate.

- **Test 2: Cable Diagnostics**

This test checks the operation of the MultiLINX Cable header pins by verifying that the Hardware Debugger commands are functional.

- **Test 3: Cable Memory**

This test is disabled for the MultiLINX Cable.

Troubleshooting

Each time a test is completed, you are informed whether the test was successful. If the test was successful, the Cable Self Check dialog box displays **PASSED** under the test name. If the test was unsuccessful, the dialog box displays **FAILED** and a description of the test failure under the test name. Failures indicate the following.

- A failure in Test 1: Communication indicates that the MultiLINX Cable is not connected correctly or that the communication port of your host system is defective.
- A failure in Test 2: Cable Diagnostics indicates that the MultiLINX Cable self test has failed. When performing a Cable Diagnostic the MultiLINX Cable LED should flash.

Cable Self Check for the XChecker Cable

Make settings in the Cable Self Check dialog box, as shown in the following figure, to specify which tests you want to perform and how these tests are conducted. After the tests are complete, the overall

results are displayed in the Cable Self Check (Results) dialog box, as shown in the “Cable Self Check (Results) Dialog Box” figure.

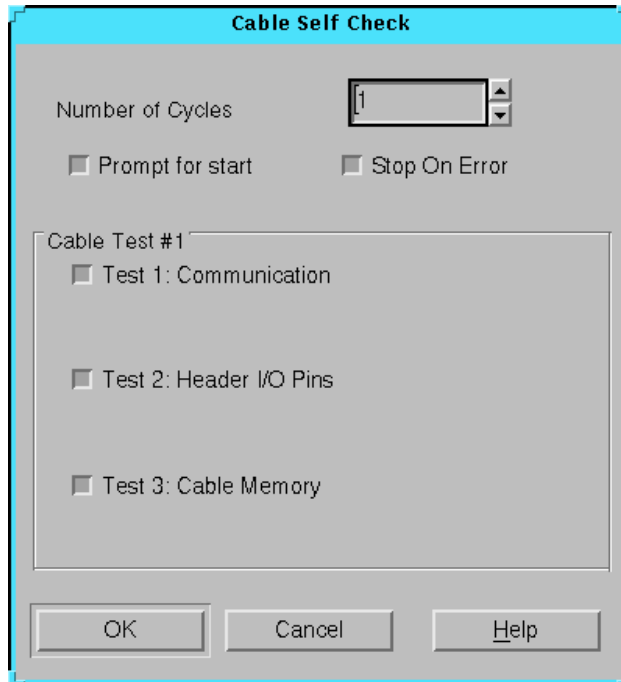

Figure 8-13 Cable Self Check Dialog Box (XChecker Cable)

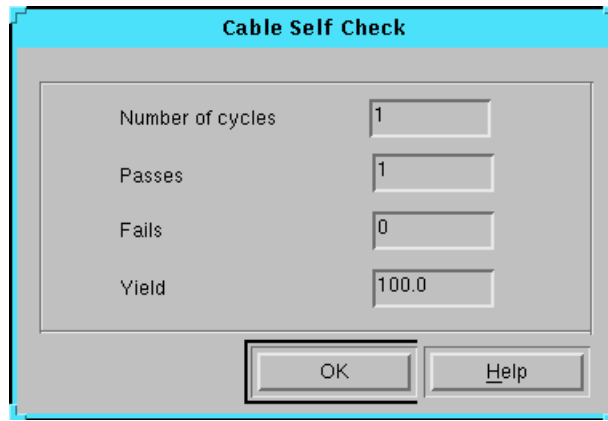

Figure 8-14 Cable Self Check (Results) Dialog Box

Cable Self Check Dialog Box

The Self Check dialog box includes the following options.

- **Number of Cycles**
Specify the number of test cycles that you want to run.
- **Prompt for Start**
Select this option to display a dialog box that allows you to manually start each test. Click **OK** in this dialog box to begin testing.
- **Stop on Error**
Select this option to stop testing when the software encounters an error. When testing stops due to an error, the status window displays the type of error encountered.
- **Cable Test #1**
Select the type or types of tests you want to run on your XChecker Cable hardware. The diagnostics routines consist of software loops that verify the functions of the cable. The following tests are run.
 - **Test 1: Communication**

This test checks the cable communication with the port on the host system at the selected baud rate.

- Test 2: Header I/O Pins

This test checks the operation of the XChecker Cable header pins by verifying that the Hardware Debugger commands are functional.

- Test 3: Cable Memory

This test checks the cable's RAM (1MB total) that is used to store, download, and readback data.

Cable Self Check (Results) Dialog Box

The Self Check (Results) dialog box includes the following fields.

- Number of Cycles

This field shows the number of test cycles that were run.

- Passes

This field shows the number of tests that passed.

- Fails

This field shows the number of tests that failed.

- Yield

This field shows the percentage of tests that passed overall.

- OK

Click **OK** to exit the dialog box.

Troubleshooting

Each time a test is completed, you are informed whether the test was successful. If the test was successful, the Cable Self Check dialog box displays **PASSED** under the test name. If the test was unsuccessful, the dialog box displays **FAILED** and a description of the test failure under the test name. Failures indicate the following.

- A failure in Test 1: Communication indicates that the XChecker Cable is not connected correctly or that the communication port of your host system is defective.

- A failure in Test 2: Header I/O Pins indicates that one or more XChecker pins are damaged.
- A failure in Test 3: Cable Memory indicates that the cable's RAM is damaged.

Note: If Test 2: Header I/O Pins or Test 3: Cable Memory fails, replace the XChecker Cable.

Settings (Debug Menu)

The Settings command brings up a submenu with commands that are enabled only if you have selected a debugging mode, Synchronous Mode or Asynchronous Mode. Refer to the listings of these submenu commands for an explanation of their functions.

The following options are available if you select **Debug** → **Synchronous Mode**.

- Trigger
- Display Signals
- Signal Groups
- CLKO Clock Source
- Number of Snapshots to Read
- Number of Clocks to Apply

The following options are available if you select **Debug** → **Asynchronous Mode**.

- Trigger
- Display Signals
- Signal Groups
- Number of Snapshots to Read

Settings → CLKO Clock Source (Debug Menu)

Select this **Debug** → **Settings** menu command to display the CLKO Clock Settings dialog box. This dialog box allows you to select an internal or external clock by clicking on the appropriate radio button.

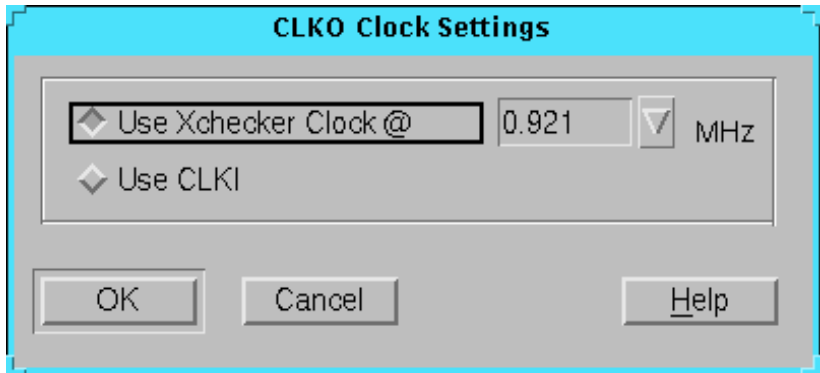

Figure 8-15 CLKO Clock Settings Dialog Box

You can also click the Clocks button in the Setup group box of the Debug Control panel to run this command.

CLKO Clock Settings Dialog Box

Use the CLKO Clock Settings dialog box to define the clock options.

- Use XChecker Clock

If you select this option, the target FPGA uses the clock from the XChecker Cable internal clock. In this case, you can also select the clock speed using the clock frequency box.

- Clock Frequency

You can set the frequency of the internal clock at 0.921, 2.764, 5.529, or 11.059 MHz.

- Use CLKI

If you select this option, you must connect your system clock to the XChecker Cable CLKI pin and the FPGA design clock to the XChecker Cable CLKO pin. The target FPGA uses the system clock. In this case, you cannot set the clock speed. The list box for the clock frequency is disabled.

- OK

Click **OK** to exit the dialog box and set the clock options.

- Cancel

Click **Cancel** to exit the dialog box without changing any settings.

Settings → Display Signals (Debug Menu)

Select this **Debug** → **Settings** menu command to display the Display Signals dialog box to select the signals, groups, and RAM bits you want to view.

Use the Display Signals dialog box to specify the signals you want to probe.

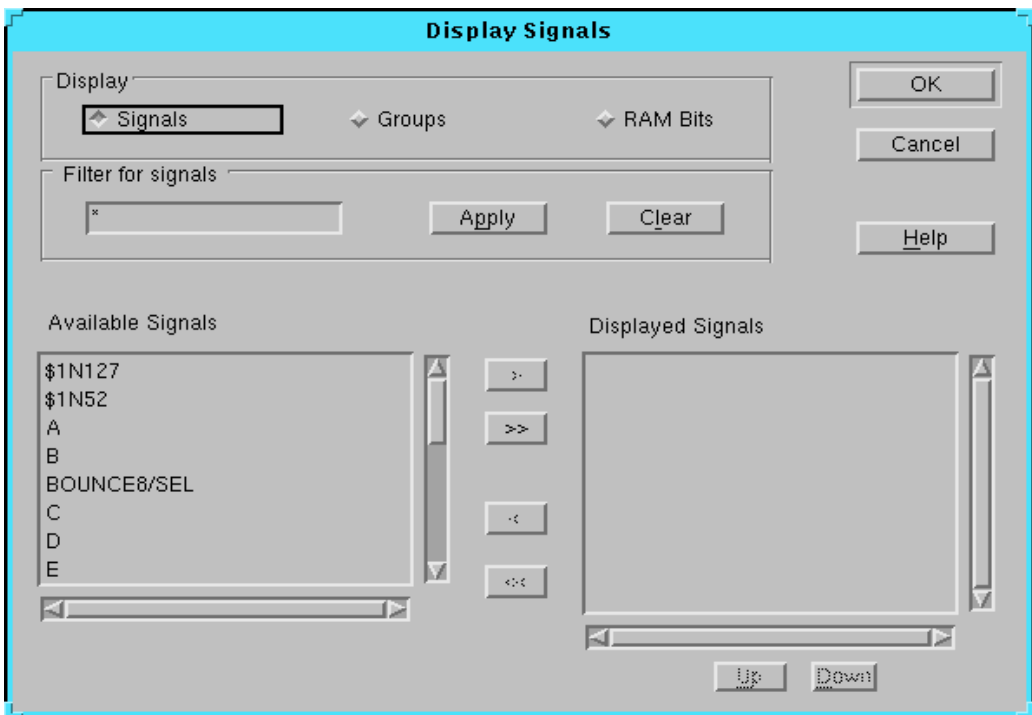

Figure 8-16 Display Signals Dialog Box

You can also click the Display button in the Clock Control group box of the Debug Control Panel to run this command.

Display Signals Dialog Box

The Display Signals dialog box includes the following options.

- **Display**
Select **Signals**, **Groups**, or **RAM Bits** to display the list of available signals, signal groups, or RAM bits.
- **Filter for Signals**
 - **Filter**
Use the **Filter** field to globally define signals, signal groups, or RAM bits you want to probe. For example, if you specify the letter “A” followed by a wildcard character (*), all signal names that start with “A” are filtered.
 - **Apply**
Click **Apply** to filter the list of signals for the specified signals.
 - **Clear**
Click **Clear** to display the complete list of signals.
- **Available Signals and Displayed Signals**
In the Available Signals list box, highlight one or more of the signals, signal groups, or RAM bits you want to view. Then move the signals to the Displayed Signals list box using the > button. Use the < button to remove a signal from the list of displayed signals.

Click the << button or the >> button to move all signals from one column to the other.

Use the **Up** and **Down** buttons to rearrange the order of the signals in the Displayed Signals column.
- **OK**
Click **OK** to exit from the dialog box and display the signals.
- **Cancel**
Click **Cancel** to exit the current dialog box without changing any settings.

Settings → Number of CLKO Clocks to Apply (Debug Menu)

Select this **Debug** → **Settings** menu command to open the Setting CLKO Clocks dialog box, shown in the following figure. Use this dialog box to specify the number of clocks to apply. When you specify the number of clocks, you specify the number of clock pulses to apply to the CLKO pin of the XChecker Cable for the target system.

Select the Apply CLKO Clock(s) command to apply the specified number of clocks.

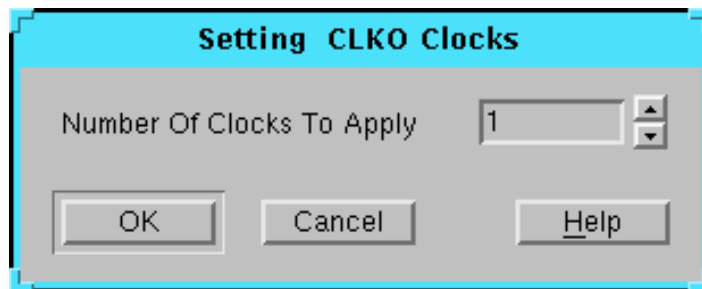

Figure 8-17 Setting CLKO Clocks Dialog Box

You can also type in the number you want in the Number of Clocks text box of the Debug Control Panel to run this command.

Settings → Number of Snapshots to Read (Debug Menu)

Select this **Debug** → **Settings** menu command to display the Snapshots Count dialog box, displayed in the following figure. Use this dialog box to specify the number of snapshots read and displayed in the current waveform. When you specify the number of snapshots, you specify the number of signal states you want to display and probe. This number is used when you select the **Debug** → **Read Snapshots** command.

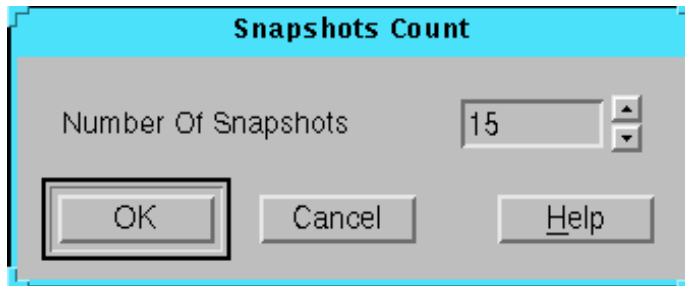

Figure 8-18 Snapshots Count Dialog Box

A snapshot provides the logical states of a device for one clock cycle. You can specify the number of clocks to apply between snapshots in the Trigger Settings dialog box for synchronous mode debugging.

You can also type in the number you want in the Number of Snapshots text box of the Debug Control Panel to perform this command.

Settings → Signal Groups (Debug Menu)

Select this **Debug** → **Settings** menu command to display the Signal Groups dialog box, which contains a list of signal groups and a list of signals. Use this dialog box to add or remove signals from a group.

Signal groups are useful for probing nodes that are related. For example, the signals a0, a1, a2, and a3 of a bus can be grouped as a signal address group.

Use the Signal Groups dialog box, to define signal groups.

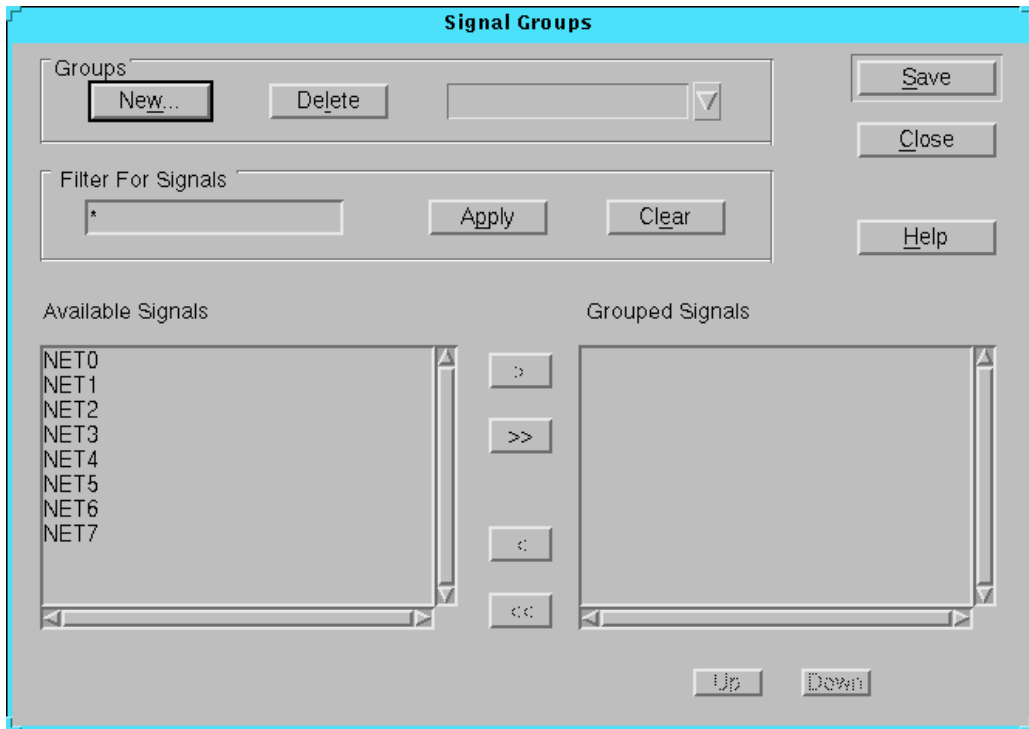

Figure 8-19 Signal Groups Dialog Box

You can also click the Groups button in the Setup group box of the Debug Control Panel to perform this command.

Signal Groups Dialog Box

The Signal Groups dialog box includes the following options.

- Groups
 - New
To create a group, click the New button to display the Group Name dialog box in which you specify a new group name.
 - Delete
To delete a group name, click the down arrow located to the right of the drop-down list box to display the list of defined

groups. Select a group from the list. After you select a group, the Delete button is enabled. Click **Delete** to remove the group from the list.

- Filter for Signals

- Filter

Use the Filter field to globally define signals you want to include under the same group. For example, if you specify the letter A followed by a wildcard (*), all signal names that start with "A" are filtered.

- Apply

Click **Apply** to filter the list of signals for the specified signals.

- Clear

Click **Clear** to display the complete list of signals.

- Available Signals and Grouped Signals

The Available Signals column contains a list of selectable signals that can be included in the current group. The Grouped Signals column contains the list of signals included in the group.

Select the signals you want to include in a group by highlighting one or more signals at a time and using the > button to move the highlighted signals to the Grouped Signals column. To remove a signal from the list of included signals, select the signal from the Grouped Signals column and use the < button.

Click the >> button or the << button to move all signals from one column to the other.

Use the **Up** and **Down** buttons to rearrange the order of the signals in the Grouped Signals column.

- Save

Click **Save** to save the new group.

- Close

Click **Close** to exit the dialog box.

Settings → Trigger (Debug Menu)

Depending on which debugging mode you select, asynchronous mode or synchronous mode, the Asynchronous or Synchronous Trigger Settings dialog box appears.

Use the Trigger Settings dialog box to select the type of trigger you want to initiate the readback. The trigger is an external signal connected to the XChecker TRIG pin that prompts the XChecker to start the readback operation.

Use the Asynchronous Trigger Settings dialog box, shown in the following figure, to specify the type of trigger to use for debugging in asynchronous mode.

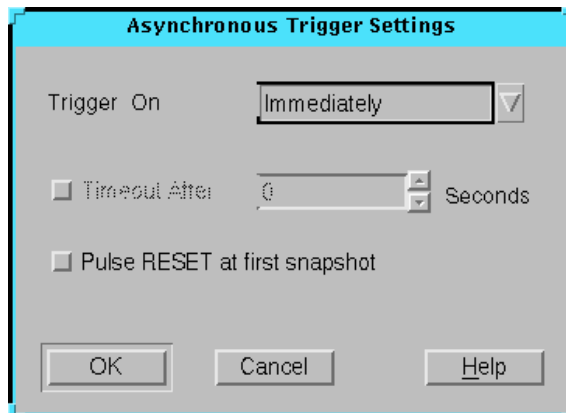

Figure 8-20 Asynchronous Trigger Settings Dialog Box

Use the Synchronous Trigger Settings dialog box, to specify the trigger type and clock cycles to use for debugging in synchronous mode.

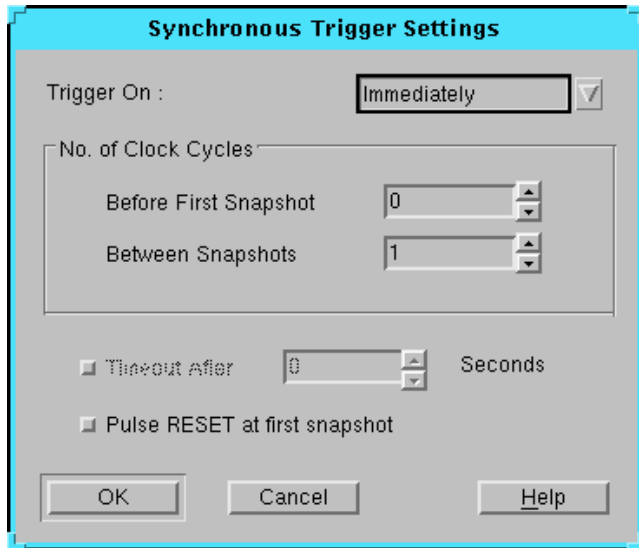

Figure 8-21 Synchronous Trigger Settings Dialog Box

You can also click the Triggers button in the Setup group box of the Debug Control Panel to perform this command.

Asynchronous Trigger Settings Dialog Box

The Asynchronous Trigger Settings dialog box includes the following options.

- Trigger On

You can initiate the readback **Immediately**, that is when the Read Snapshots command is displayed, or you can choose to use an **External** pin or the **Enter Key** to initiate the readback.

The External Trigger is an auto-trigger that is activated when the TRIG pin of the XChecker Cable goes from Low (0) to High (1).

- Timeout After

Use this option to specify the cutoff time for a trigger to be detected. If the trigger is not received within the specified number of seconds, the readback is canceled. Valid values range from 0 to 99.

- Pulse RESET at First Snapshot
Use this option to initialize the device flip-flops. By default, this option is deselected.
- OK
Click **OK** to exit the dialog box and set the specified options.
- Cancel
Click **Cancel** to exit the dialog box without changing any settings.

Synchronous Trigger Settings Dialog Box

The Synchronous Trigger Settings dialog box includes the following options.

- Trigger On
You can initiate the readback **Immediately**, that is when the Read Snapshots command is displayed, or you can use an **External** pin or the **Enter Key** to initiate the readback.
The External Trigger is an auto-trigger that is activated when the TRIG pin of the XChecker Cable goes from Low (0) to High (1).
- Number of Clock Cycles
This option allows you to define specific clock patterns. You can specify the number of clock cycles to be applied before the first snapshot and between snapshots. Use this option to advance the device a specific number of states before the first snapshot and to determine how many clocks are applied to the target FPGA between snapshots.
This option combined with the Number of Snapshots to Read command allows you to use these clock patterns to gather the device states you want. Use these options together to specify the states of the bitstream you want to display and probe.
- Timeout After
This option allows you to specify the cutoff time for a trigger to be detected. If the trigger is not received within the specified number of seconds, the readback is canceled. Valid values range from 0 to 99.

- Pulse RESET at First Snapshot
Use this option to initialize the device flip-flops. By default, this option is deselected.
- OK
Click **OK** to exit the dialog box and set the specified options.
- Cancel
Click **Cancel** to exit the current dialog box without changing any settings.

Start CLKO (Debug Menu)

Select this command to allow the system clock to freely oscillate. This option is available only if you have selected the synchronous debugging mode.

You can also click the Start button in the Clock Control group box of the Debug Control Panel to perform this command.

Status Bar (View Menu)

Select this command to show or hide the Hardware Debugger status bar. The status bar, located at the bottom of the Hardware Debugger window, provides information about the commands being processed. It also provides a description of menu commands or the toolbar buttons that are in focus.

Stop CLKO (Debug Menu)

Select this command to interrupt the system clock being applied to the target device through the CLKO pin of the XChecker Cable. This option is available only if you have selected the synchronous debugging mode.

You can also click the Stop button in the Clock Control group box of the Debug Control Panel to perform this command.

Synchronous Mode (Debug Menu)

Select this command to set the debug mode to synchronous debugging. In synchronous mode, you control the FPGA system clock through the Hardware Debugger and the XChecker Cable.

Debugging is available only if the cable selected is an XChecker Cable and if the current file is a BIT file. Make sure to prepare your design for debugging as specified in the “Design Preparation” chapter. Make sure you configure the XChecker Cable as specified for synchronous mode in the “Connecting Your Cable” chapter.

After you select a debug mode, the Settings submenu commands and the options in the Debug Control Panel are activated for the appropriate mode.

You can also click the following toolbar button to run this command.



Text Data (View Menu)

Select this command to display the readback data textually rather than graphically.

In the text mode, the waveform window displays a textual representation of the device states you specified for debugging. The text window, in the following figure, is a tabular display of the readback information. See the “Waveform Window (Textual View)” section of the “Customizing the Interface” chapter for a detailed description of the text data waveform window.

windows are visible. The active window processes the commands you invoke.

Tile Vertically (Window Menu)

Select this command to arrange open windows next to one another in a vertical arrangement within the main window so that all windows are visible. The active window processes the commands you invoke.

Toolbar (View Menu)

Select this command to show or hide the Hardware Debugger toolbar. The toolbar, located below the menu bar, displays several buttons that you can use to perform certain menu commands. The toolbar offers an alternative to the menu commands. See the “Toolbar Buttons” section for a description of the toolbar buttons.

Undo (Edit Menu)

Select this command to undo the most recent Edit menu command.

Verify Bitstream (Download Menu)

Select this command to initiate a readback of the downloaded design and compare the readback data to the original bitstream that was downloaded. The status of the verification is displayed in a dialog box. This command is active only if you are using an XChecker Cable and if the current file is a BIT file configured for verification. See the “Verifying Design Logic” section of the “Programming a Device or a Daisy Chain” chapter for information on how to use this command.

You can also click the following toolbar button to perform this command.



Waveform Data (View Menu)

Select this command to display the readback signal values graphically rather than textually.

The waveform window, shown in the following figure, displays a graphical representation of the device states you specified for debugging. See the “Waveform Window (Graphical View)” section of the “Customizing the Interface” chapter for a detailed description of the graphical waveform window.

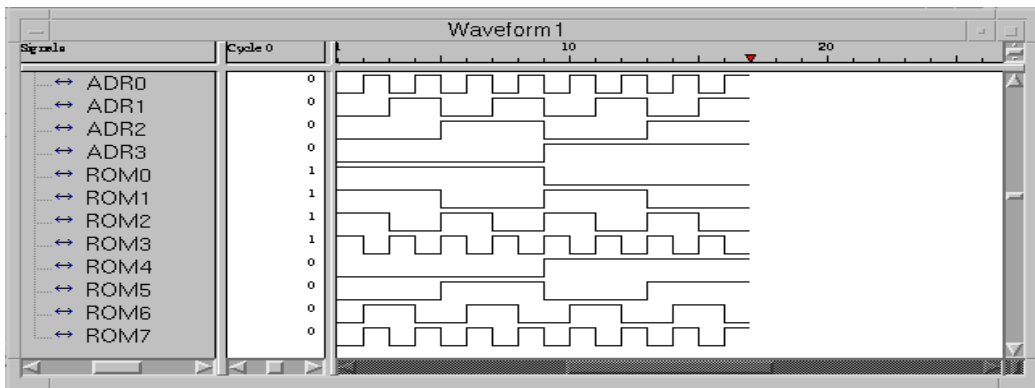

Figure 8-23 Waveform Window

You can also click the following button to run this command.



Zoom In (View Menu)

Select this command to zoom in on the current waveform.

You can also click the following toolbar button to run this command.



Zoom Out (View Menu)

Select this command to zoom out on the current waveform.

You can also click the following toolbar button to run this command.



Zoom Reset (View Menu)

Select this command to reset the waveform view to the default settings.

You can also click the following toolbar button to run this command.



Zoom to Fit (View Menu)

Select this command to fit the selected waveform to the current size of the screen. This command operates when a graphical waveform window is the active window.

You can also click the following toolbar button to run this command.



Toolbar Buttons

The toolbar provides convenient access to frequently used commands. Click once on a toolbar button to perform a command.

If you position the mouse pointer over a toolbar button, a short description appears next to the button and a longer description appears in the status bar at the bottom of the main window.

This section briefly describes the function of each toolbar button and includes a graphic of each button.

New

The New button creates a new project. It is equivalent to the File → New → Project command.



Open

The Open button opens an existing project. It is equivalent to the File → Open → Project command.



Save

The Save button saves the document. It is equivalent to the File → Save command.



Close

The Close button closes the project, macro, or waveform. It is equivalent to the File → Close command.



Run Macro

The Run Macro executes the selected macro. It is equivalent to the File → Run Macro command.



Download Design

The Download Design button downloads the configuration data to your target device or chain of devices. It is equivalent to the Download → Download Design command.



Download and Verify

The Download Design and Verify button downloads the design file to your target device and verifies that the design was downloaded.

correctly. It is equivalent to the Download → Download and Verify command.



Verify Bitstream

The Verify Bitstream button verifies that the design was downloaded correctly. It is equivalent to the Download → Verify Bitstream command.



Readback and Capture

The Readback and Capture button performs readback on a device and stores the data into a file.



Synchronous Debug

The Synchronous Debug button enables the synchronous debug mode. It is equivalent to the Debug → Synchronous Mode command.



Asynchronous Debug

The Asynchronous Debug button enables the asynchronous debug mode. It is equivalent to the Debug → Asynchronous Mode command.



Waveform Data

The Waveform Display button displays the readback data graphically. It is equivalent to the View → Waveform Data command.



Text Data

The Text Display button displays the readback data in text format. It is equivalent to the View → Text Data command.



Zoom In

The Zoom In button allows you to zoom in on your waveform. It is equivalent to the View → Zoom In command.



Zoom Out

The Zoom Out button enables you to zoom out from your waveform. It is equivalent to the View → Zoom Out command.



Zoom to Fit

The Zoom to Fit button enables you to zoom to fit the screen. It is equivalent to the View → Zoom to Fit command.



Zoom Reset

The Zoom Reset button resets the view to default values.



Help

The Help button displays context-sensitive help.



Appendix A

Glossary of Terms

This appendix contains definitions and explanations for terms commonly used in the Hardware Debugger program.

asynchronous debugging

A debugging mode in which you capture data without controlling your system clock through the Hardware Debugger.

BIT file

A synonym for a configuration bitstream file.

bitstream (BIT file)

A data stream, also called BIT file, that contains location information of logic on a device, that is, the placement of CLBs, IOBs, TBUFs, pins, and routing elements. The bitstream also includes empty placeholders that are filled with the logical states sent by the device during a readback. Only the memory elements, such as flip-flops, RAMs, and CLB outputs, are mapped to these placeholders, because their contents are likely to change from one state to another. When downloaded to a device, a bitstream programs the device.

A bitstream file has a .bit extension.

CCLK pin

The pin of the configuration cable that connects the configuration clock to the device.

CFG_DONE pin

This pin has the same functionality as the \sim PROGRAM pin on the XC4000, XC5200, and Spartan FPGAs. The CFG_DONE pin is a MultiLINX Target Interface Pin.

CFG_RDY pin

When asserted, this pin indicates that the FPGA is ready to receive configuration data. When de-asserted, the pin indicates that either the FPGA is in the power-up mode, or a configuration error has occurred. This pin has the same functionality as the INIT pin on the Spartan, XC3000, XC4000, and XC5200 FPGAs. The CFG_RDY pin is a MultiLINX Target Interface Pin.

CFG_RESET pin

This pin has the same functionality as the \sim PROGRAM pin on the XC4000, XC5200, and Spartan FPGAs. The CFG_RESET pin is a MultiLINX Target Interface Pin.

CLKI pin

XChecker and MultiLINX cables clock input pin. This pin connects the system clock to the XChecker Cable. The frequency of this clock must be in the range of 120 kHz to 10 MHz. Connecting the system clock to the CLKI pin allows the Hardware Debugger to control the system clock so that snapshots are captured while the design is in a known state. If the clock source is external, the clock signal is connected to the CLKI pin; if it is internal, the clock signal is generated by the XChecker Cable electronics.

CLKO pin

XChecker and MultiLINX cables clock output pin. This pin connects to the destination of the target system clock. Connecting the CLKO pin to the system clock allows the Hardware Debugger to control the system clock so that snapshots are captured while the design is in a known state.

console log

A record of the commands that you executed during a Hardware Debugger session.

control panel

A dialog box in the Hardware Debugger that consists of buttons and fields for debugging purposes. The control panel is displayed if the Hardware Debugger detects that readback is enabled for a design. The control panel commands offer an alternative to the Debug menu commands.

CS/CS0 pin

CS on the Virtex; and CS0 on the XC4000 and XC5200 FPGAs. The CS/CS0 pin represents a chip select to the target FPGA during configuration. The CS/CS0 pin is a MultiLINX Target Interface Pin.

CS1 pin

Chip Select to the XC4000 and XC5200 FPGAs during configuration. The CS1 pin is a MultiLINX Target Interface Pin.

CS2 pin

Chip Select to the XC3000 FPGA while using the Peripheral configuration mode. The CS2 pin is a MultiLINX Target Interface Pin.

debugging

The process of reading back or probing the states of a configured device to ensure that the device is behaving normally while in circuit.

DIN pin

The Data In pin of the configuration cable connects to the DIN pin of your target device. In serial mode, the DIN pin loads the bitstream data to the target FPGA.

DONE pin (XC4000/XC5200)

This pin connects to the DONE pin of your target FPGA. It indicates the completion of the configuration process. During configuration, this pin is Low. After configuration, this pin is High.

downloading

Configuring or programming a device by sending bitstream data to the device.

D/P pin (XC3000)

The dual function Done/Program pin of your configuration cable. The pin connects to the D/P pin on your target device. As an input, D/P=0 is used to initiate a device reconfiguration. As an output, D/P=1 signals the end of configuration.

D0-D7 pins

An 8 bit data bus supporting the Express, and SelectMAP configuration modes. The D0-D7 pins are MultiLINX Target Interface Pins.

external clock

The clock connected to the XChecker CLKI pin that the Hardware Debugger uses for synchronous mode debugging. To use an external clock, connect the system clock to the XChecker Cable using the CLKI pin and connect the XChecker CLKO pin to the system clock loads.

GND pin

Ground (0 volt) pin of the configuration cable. This pin connects to the Ground pin of a power supply.

group

A combination of signals that have a common output. In the case of a counter, for example, the different signals that produce the actual counter values can be grouped under the same name and share a common representation.

INIT pin

Initialization pin on your configuration cable. This pin is connected to the INIT pin of your target device indicating when a device is ready to receive configuration data after power up. During configuration, INIT=0 indicates a configuration error.

internal clock

The clock provided by the XChecker Cable. This clock is generated in the XChecker Cable electronics and is output on the CLKO pin. It is available in synchronous mode and is controlled from the Hardware Debugger.

(.II) file

The logic allocation file, which indicates the bitstream position of elements that can be probed, such as latches, flip-flops, and IOB inputs and outputs. The Hardware Debugger uses this file to locate signal values inside a readback bitstream. This file is created during the implementation process if readback is enabled.

(.msk) file

The mask file, (.msk) file indicates which bits are configuration bits and which ones are not. This file is needed to do a verify operation on a Virtex family device using the MultiLINX Cable. This file is generated during the implementation process (BitGen) if readback is enabled in the “Configuration Template”.

main window

The background against which other windows are displayed in the Hardware Debugger.

menu bar

The area located at the top of the Hardware Debugger window. It includes the File, Cable, Download, Debug, View, Window, and Help menus. Refer to the “Menu Commands” chapter for information on the menu commands.

number of clock cycles

The number of clocks that occur between snapshots. When capturing multiple snapshots during synchronous mode debugging, the number of snapshots is used as a trigger for capturing each snapshot.

probing

The process of examining the signal states of an FPGA device.

PROG pin

The Program pin of your configuration cable provides a reprogram pulse to XC4000 and XC5200 devices when connected to the PROG pin of the device.

PROM file

A PROM file is the file output by the PROM File Formatter, which can be used to program one or more devices. The PROM File Formatter supports the following PROM file formats: MCS (Intel MCS-86), EXO (Motorola EXORMacs), TEKHEX (Tektronix hexadecimal), and HEX.

RBT file

A raw BIT format file, the ASCII version of the BIT file.

RD(TDO) pin

The readback data pin of the XChecker Cable and the MultiLINX Cable. This pin connects to the RDATA pin of the device. When connected, the pin reads data from the programmed target device.

RDWR pin

The RDWR pin is used as an active high READ and an active low WRITE control signal to the Virtex FPGA. The RDWR pin is a Multi-LINX Target Interface Pin.

RDY/BUSY pin

Use the BUSY pin overfertilize devices and the RDY/~BUSY pin on the XC3000, XC4000, and XC5200 FPGAs. The RDY/BUSY pin is a MultiLINX Target Interface Pin.

readback

The process of reading the logic downloaded to an FPGA device. There are two types of readbacks.

- A readback with a filter that extracts the configuration bits to verify that a design was downloaded correctly.
- A readback with a filter that extracts the state of design storage elements, CLB outputs, and IOB outputs to ensure that the device is behaving as expected.

RS pin

Read Select control for the Asynchronous Peripheral configuration mode on XC4000 and XC5200 FPGAs. The RS pin is a MultiLINX Target Interface Pin.

RST pin

The Reset pin of the XChecker Cable and the MultiLINX Cable connects to the RST pin of the target device. This pin is driven Low by the Hardware Debugger after configuration to initialize the target XC3000 FPGA internal latches and flip-flops. After configuration, this pin can be used as an active-Low reset when debugging XC4000 and XC5200 devices.

For XC4000 and XC5200 devices, the FPGA expects an active-High reset, but the Hardware Debugger produces an active-Low reset pulse. Users should invert the reset pulse before driving the GSR pin on the STARTUP symbol.

RT pin

The readback trigger pin of the XChecker Cable and the MultiLINX Cable. This pin connects to the device RTRIG pin. When the

XChecker Cable drives this pin High, the pin initiates a readback on the target FPGA.

snapshot

Readback data that contains the values of all storage elements, CLB outputs, and IOB inputs and outputs of a design at a point in time.

In the waveform window, each snapshot is marked by a red triangle.

states

The values stored in the memory elements of a device (flip-flops, latches, RAMs, CLB outputs, and IOBs) that represent the state of that device for a particular readback. To each state there corresponds a specific set of logical values.

status bar

The field located at the bottom of the Hardware Debugger window. It provides information about the commands that you are about to select or that are already being processed.

synchronous debugging

A debugging mode in which you use the XChecker Cable to control your system clock so that snapshots can be captured while the design is in a known state.

TCK pin

In the Hardware Debugger, an XChecker Cable and MultiLINX Cable pin reserved for future use. It can be used as a digital probe point using the Cable → Logic Level of Pins command.

TDI pin

In the Hardware Debugger, an XChecker Cable and MultiLINX Cable pin reserved for future use. It can be used as a digital probe point using the Cable → Logic Level of Pins command.

TMS pin

In the Hardware Debugger, an XChecker Cable and MultiLINX Cable pin reserved for future use. It can be used as a digital probe point using the Cable → Logic Level of Pins command.

toolbar

A field located under the menu bar at the top of the main window. It contains a series of buttons that execute some of the most frequently used commands. These buttons constitute an alternative to the menu commands.

TRIG pin

The external trigger pin of the XChecker Cable and the MultiLINX Cable. This pin is connected to an external signal used as a trigger. A Low to High transition on this pin signals the cables to initiate a read-back.

trigger

A signal that tells the Hardware Debugger to read a snapshot.

VCC pin

Power (5 volt) pin of the XChecker Cable. This pin connects to the power pin of a 5 volt power supply.

verification

The process of reading back the configuration data and comparing it to the original downloaded design to ensure that all of the design was received by the device.

waveform

The graphical representation of one or more readbacks. Usually, you select a set of signals and a set of readbacks for display. Each read-back represents a particular state of the memory elements of the device.

WS pin

Write Select control for the Asynchronous Peripheral configuration mode on XC4000 and XC5200 FPGAs during configuration. The WS pin is a MultiLINX Target Interface Pin.

Console Commands

Console commands are entered from the Console window. You can use console commands as an alternative to menu commands. Console commands do not display the dialog and message boxes associated with the menu commands. To get command feedback, you can use the Force command. Additionally, you can also turn on the Show Command Status check box in the Console window. This chapter contains the following sections.

- “Conventions”
- “Alphabetical Listing of Commands”

To automate design debugging, you can copy commands from the Console window into a macro window to build macros. See the “Using Macros” section of the “Customizing the Interface” chapter for information.

Note: Do not use console commands until you are familiar with the graphical user interface commands because console commands must be executed in a particular order.

Conventions

The following is a summary of the syntax used for Console commands.

- When an option occurs without parentheses “()” next to the command name in the syntax, it is required. When it appears in square brackets “[],” the variable is optional.
- When two or more options occur between braces “{ },” they must be entered with the command. If the options are separated by a vertical bar “|,” you must choose one of the possible parameters. If one term is divided into a subset of parameters that can be

entered separately or together, each subparameter occurs between square brackets.

Alphabetical Listing of Commands

The following summarizes the console commands discussed in this chapter.

Baud	Sets the baud rate
Cable	Sets the cable options
Clock	Sets the clock options
Display	Selects the signals to debug
Download	Programs target device with the current design
Exit	Exits the Hardware Debugger
Force	Displays or hides the message boxes
Group	Defines groups of signals for debugging
Open	Loads the configuration data
Port	Selects the communications port
Readfpga	Reads the device states using the specified debugging settings (snapshot number, signals, and groups)
Reset	Reinitializes the target device
Run	Executes the macro in the current macro window
Setmode	Selects the debugging mode, synchronous or asynchronous
Trigger	Selects the source of the readback trigger
Verify	Verifies the design was downloaded correctly

Note: The Clock, Display, Group, Readfpga, and Setmode commands are not available when using the MultiLINX Cable.

Baud

Use this command to set the cable baud rate

Syntax

```
baud rate
```

Parameters

This command has one parameter.

rate specifies the rate at which the data is transferred between the computer and the serial or XChecker Cable and MultiLINX Cable; this parameter can be set to {9600 | 19200 | 38400 | 15200}

Note: The 115200 baud rate is valid only on HP and PC platforms. For the MultiLINX Cable replace “115200” with “57600”.

Examples

Following is an example of how to specify the Baud command.

```
baud 38400
```

Abbreviations

You can abbreviate the Baud command as follows

```
baud      bau
```

Cable

Use this command to set the cable options and to specify the type of cable.

Syntax

```
cable {option | name}
```

Parameters

The variables of the Cable command are further divided into the following parameters.

- *option* {-reset | -check | -pins}
 - -reset reprograms the XChecker cable.
 - -check tests the cable operation.
 - -pins checks the logic levels of the XChecker pins.
- *name* {multilinx | xchecker | serial | parallel}
 - multilinx establishes communication with the MultiLINX cable
 - xchecker establishes communication with the XChecker cable.
 - serial establishes communication with a serial cable.
 - parallel establishes communication with a parallel cable.

Examples

Following are examples of how to specify the Cable command.

```
cable -pins
cable -xchecker
```

Abbreviations

You can abbreviate the Cable command and its options as follows.

<code>cable</code>	<code>cab</code>
<code>-reset</code>	<code>-rs</code>
<code>-check</code>	<code>-chk</code>
<code>-pins</code>	<code>-pn</code>

Clock

The Clock command is a synchronous mode debugging option. It enables you to specify the clock options, namely the clock type and speed. It also enables you to specify the number of clocks to apply to the target device during debugging.

Syntax

The syntax of the Clock command is the following.

```
clock {[source][speed] | apply_clocks | control_option}
```

Parameters

The variables of the Clock command are further divided into the following parameters.

- *source* {-internal | -external}
 - -internal sets the clock source to XChecker internal clock
 - -external sets the clock source to external/user clock
- *speed* -speed {1 | 3 | 5 | 11}
 - -speed sets the speed of the clock.
- *apply_clocks* -apply {number}
 - -apply cycles the device forward the number of clocks you specify
- *control_option* {-stop | -resume}
 - -stop interrupts the clock source
 - -resume resumes the clock source

Examples

Following are examples of how to specify the Clock command.

```
clock -internal -speed 3
clock -apply 4
clock -stop
```

Abbreviations

You can abbreviate the Clock command and its options as follows.

```
clock      clk
-internal  -int
```

```
-external  -ext
-apply    -ap
-stop     -st
-resume   -res
```

Display

The Display command specifies which nets to debug.

Syntax

The syntax of the Display command is the following.

```
display operation list_of_signals
```

Parameters

The variables of the Display command are further divided into the following parameters.

- *operation* {-del | -add}
 - -del deletes the specified list of signals and/or group names from the display list
 - -add adds the specified signals and group names to the display list
- *list_of_signals* { [*list_of_signals*] [*group_names*] | *}
 - *list_of_signals* is the list of signals you wish to probe
 - *group_names* is the list of defined signal groups you wish to probe
 - * is the complete list of signals and groups in your design if you are adding signals. It refers to the signals in the display list if you are removing signals.

Examples

Following are examples of how to specify the Display command.

```
display -add A B C D E F G ALUOUT SWITCHES
display -del *
```

Abbreviations

You can abbreviate the Display command as follows.

```
display      dply
```

Download

Use the Download command to program a device by downloading the current design to that device.

Syntax

The syntax of the Download command is the following.

```
download [-verify]
```

Parameters

The Download command has one parameter.

-verify reads back the data that was downloaded to the target device and compares it to the original data.

Examples

Following is an example of how to specify the Download command.

```
download -verify
```

Abbreviations

You can abbreviate the Download command as follows.

```
download      dn  
-verify      -v
```

Exit

The Exit command enables you to exit the Hardware Debugger program.

Syntax

The syntax of the Exit command is the following.

```
exit
```

Parameters

The Exit command has no parameters.

Examples

Following is an example of how to specify the Exit command.

```
exit
```

Abbreviations

You can abbreviate the Exit command as follows.

```
exit      ex
```

Force

The Force command enables you to display or hide information dialog boxes while a macro is running.

Syntax

The syntax of the Force command is the following.

```
force setting
```

Parameters

The parameters of the Force command are the following.

```
setting {-on | -off}
```

- -on displays the information dialog boxes
- -off hides the information dialog boxes

Examples

Following is an example of how to specify the Force command.

```
force -on
```

Abbreviations

You can abbreviate the Force command and its options as follows.

<code>force</code>	<code>for</code>
<code>-on</code>	<code>-o</code>
<code>-off</code>	<code>-f</code>

Group

The Group command enables you to specify signal groups to debug as entities. It also allows you to delete existing groups of signals.

Syntax

The syntax of the Group command is the following.

```
group {del_group | new_group}
```

Parameters

The variables of the Group command can be divided into the following parameters.

- *del_group* is `-del groupname list_of_signals`
 - `-del` deletes the specified signals from the specified group name
 - *groupname* is the name of the group you are defining
 - *list_of_signals* is the list of signals you are adding or removing from the group
- *new_group* is `groupname list_of_signals` and adds the specified signals and group names to the display list
 - *groupname* is the name of the group you are defining
 - *list_of_signals* is the list of signals you are adding or removing from the group

Examples

Following is an example of how to specify the Group command.

```
group aluout ALU0 ALU1 ALU2 ALU3 ALU4
group -del aluout ALU2
```

Abbreviations

You can abbreviate the Group command as follows.

```
group      gp
```

Open

The Open command opens a file for downloading.

Syntax

The syntax of the Open command is the following.

```
open file
```

Parameters

The variables of the Open command can be divided into the following parameters.

file {\ *file_path* \ *file_name*} or *file* { / *file_path* / *file_name*}

- *file_path* is the drive and directory in which your design is located
- *file_name* is the name of the design you want to open

Examples

Following is an example of how to specify the Open command.

```
open C:\TMP\4KACALC\CALC4K.BIT
```

Abbreviations

You can abbreviate the Open command as follows.

`open` `op`

Port

The Port command enables you to select the communications port you need for your cable.

Syntax

The syntax of the Port command is the following.

```
port port_name
```

Parameters

The parameters of the Port command are the following.

port_name is

{auto} for auto-detection of cable

{com1 | com2 | com3 | com4} for XChecker or serial cables on PC platforms

{/dev/tty00 | /dev/tty01} for XChecker or serial cables on HP platforms

{/dev/ttya | /dev/ttyb} for XChecker or serial cables on Sun platforms

{lpt1 | lpt2 | lpt3 | lpt4} for parallel cable only

Examples

Following are examples of how to specify the Port command.

```
port com1
```

```
port lpt2
```

Abbreviations

You can abbreviate the Port command as follows.

`port` `po`

Readfpga

The Readfpga command enables you to capture snapshots of the states of a device.

Syntax

The syntax of the Readfpga command is the following.

```
readfpga snapshots
```

Parameters

The parameters of the Readfpga command are *snapshots* {1–65534}

Examples

Following is an example of how to specify the Readfpga command.

```
readfpga 4
```

Abbreviations

You can abbreviate the Readfpga command as follows.

```
readfpga    rea
```

Reset

The Reset command enables you to reset the FPGA. The reset signal is active-Low.

Syntax

The syntax of the Reset command is the following.

```
reset
```

Parameters

There are no parameters for the Reset command.

Examples

Following is an example of how to specify the Reset command.

```
reset
```

Abbreviations

You can abbreviate the Reset command as follows.

```
reset      res
```

Run

The Run Command executes the macro defined in the current macro window.

Syntax

The syntax of the Run command is the following.

```
run file_name
```

Parameters

The Run command has one parameter.

file_name is the name of the design you want to run

Examples

Following is an example of how to specify the Run command.

```
run calc4k.bit
```

Abbreviations

You can abbreviate the Run command as follows.

```
run      rn
```

Setmode

The Setmode command enables you to set the debugging mode.

Syntax

The syntax of the Setmode command is the following.

```
setmode debugmode
```

Parameters

The parameters of the Setmode command are the following.

- `debugmode` {`-sync` | `-async`}
- `-sync` turns on the synchronous mode debugging
- `-async` turns on the asynchronous mode debugging

Examples

Following is an example of how to specify the Setmode command.

```
setmode -sync
```

Abbreviations

You can abbreviate the Setmode command and its options as follows.

<code>setmode</code>	<code>md</code>
<code>-synch</code>	<code>-s</code>
<code>-async</code>	<code>-as</code>

Trigger

The Trigger command specifies the source of the readback trigger.

Syntax

The syntax of the Trigger command is the following.

```
trigger {timing | clocksettings | option}
```

Parameters

The parameters of the Trigger command are the following.

- `timing` {`-immediately` | `-external` | `-enterkey`} sets the trigger type
- `clocksettings` `-clock` {`before_first_snapshot` `between_snapshots`} specifies the clock patterns to apply to the target device.

- *option* {-timeout *num* | -reset}
 - {-timeout *num*} specifies the cutoff time for a trigger to be received
 - -reset reinitializes the target device

Examples

Following is an example of how to specify the Trigger command.

```
trigger -immediately -clock 2 2 -timeout 10-reset
```

Abbreviations

You can abbreviate the Trigger command as follows.

```
trigger      tr
```

Verify

The Verify command enables you to verify that the design was downloaded correctly.

Syntax

The syntax of the Verify command is the following.

```
verify
```

Parameters

The Verify command has no parameters.

Examples

Following is an example of how to specify the Verify command.

```
verify
```

Abbreviations

You can abbreviate the Verify command as follows.

```
verify      ver
```

